

The Hyper-Text Transfer Protocol (HTTP)

Antonio Carzaniga

Faculty of Informatics
Università della Svizzera italiana

March 2, 2020

- HTTP message formats
- HTTP methods
- Status codes
- Headers
- Web caching

Anatomy of a Request

GET /carzaniga/index.html HTTP/1.1	
Host: www.inf.usi.ch	
Connection: close	
User-agent: Mozilla/4.0	
Accept-Language: it	

Anatomy of a Request

GET /carzaniga/index.html HTTP/1.1	request line
Host: www.inf.usi.ch	
Connection: close	
User-agent: Mozilla/4.0	
Accept-Language: it	

Anatomy of a Request

GET /carzaniga/index.html HTTP/1.1	request line
Host: www.inf.usi.ch	zero or more header lines
Connection: close	
User-agent: Mozilla/4.0	
Accept-Language: it	

Anatomy of a Request

GET /carzaniga/index.html HTTP/1.1	request line
Host: www.inf.usi.ch	zero or more header lines
Connection: close	
User-agent: Mozilla/4.0	
Accept-Language: it	empty line

Anatomy of a Request

GET /carzaniga/index.html HTTP/1.1	request line
Host: www.inf.usi.ch Connection: close User-agent: Mozilla/4.0 Accept-Language: it	zero or more header lines
	empty line
	object body (possibly empty)

Anatomy of a Request (2)

- Request line

```
GET /carzaniga/index.html HTTP/1.1
```

- Request line

```
GET /carzaniga/index.html HTTP/1.1
```

↑
method

- Request line

space
↓
GET /carzaniga/index.html HTTP/1.1
↑
method

Anatomy of a Request (2)

- Request line

The diagram shows the request line `GET /carzaniga/index.html HTTP/1.1` with annotations. An upward arrow from the word *method* points to `GET`. A downward arrow from the word *space* points to the space between `GET` and `/carzaniga/index.html`. An upward arrow from the word *URL* points to `/carzaniga/index.html`. A downward arrow from the word *space* points to the space between `/carzaniga/index.html` and `HTTP/1.1`.

```
GET /carzaniga/index.html HTTP/1.1
```

Anatomy of a Request (2)

■ Request line

space

↓

GET /carzaniga/index.html HTTP/1.1

↑

method URL version

space

↓

↑

The diagram shows the request line `GET /carzaniga/index.html HTTP/1.1`. A vertical arrow labeled `space` points down from the space before `GET` to the `GET` text. Another vertical arrow labeled `space` points down from the space before `HTTP/1.1` to the space between `index.html` and `HTTP/1.1`. Vertical arrows point up from the labels `method`, `URL`, and `version` to the `GET`, `/carzaniga/index.html`, and `HTTP/1.1` parts of the request line, respectively.

Anatomy of a Request (2)

■ Request line

space ↓ *space*
GET ↓ /carzaniga/index.html ↓ HTTP/1.1
↑ ↑ ↑
method *URL* *version*

■ Header line

Host: www.inf.usi.ch

Anatomy of a Request (2)

■ Request line

space ↓
GET /carzaniga/index.html HTTP/1.1
↑ ↓
method *URL* *version*

■ Header line

Host: www.inf.usi.ch
↑
name

Anatomy of a Request (2)

■ Request line

space ↓ *space*
GET ↓ /carzaniga/index.html ↓ HTTP/1.1
↑ ↑ ↑
method *URL* *version*

■ Header line

space ↓
Host: ↓ www.inf.usi.ch
↑
name

Anatomy of a Request (2)

■ Request line

space ↓ *space*
GET ↓ /carzaniga/index.html ↓ HTTP/1.1
↑ ↑ ↑
method *URL* *version*

■ Header line

space ↓
Host: ↓ www.inf.usi.ch
↑ ↑
name *value*

■ Line terminator: *CRLF* ("carriage return" and "line feed")

- ▶ two bytes: numeric values 13 and 10

GET retrieve the object identified by the URL

GET retrieve the object identified by the URL

OPTIONS requests the available communication options for the given object

GET retrieve the object identified by the URL

OPTIONS requests the available communication options for the given object

HEAD like GET, but without the body

- useful for testing the validity of links

GET retrieve the object identified by the URL

OPTIONS requests the available communication options for the given object

HEAD like GET, but without the body

- useful for testing the validity of links

POST allows one to submit data to the server

- e.g., a mail message in a web mail system, a form in an e-commerce site...
- the given URL is the object that *handles* the posting

GET retrieve the object identified by the URL

OPTIONS requests the available communication options for the given object

HEAD like GET, but without the body

- useful for testing the validity of links

POST allows one to submit data to the server

- e.g., a mail message in a web mail system, a form in an e-commerce site...
- the given URL is the object that *handles* the posting

PUT requests that the enclosed object be stored under the given URL

GET retrieve the object identified by the URL

OPTIONS requests the available communication options for the given object

HEAD like GET, but without the body

- useful for testing the validity of links

POST allows one to submit data to the server

- e.g., a mail message in a web mail system, a form in an e-commerce site...
- the given URL is the object that *handles* the posting

PUT requests that the enclosed object be stored under the given URL

DELETE deletes the given object

GET retrieve the object identified by the URL

OPTIONS requests the available communication options for the given object

HEAD like GET, but without the body

- useful for testing the validity of links

POST allows one to submit data to the server

- e.g., a mail message in a web mail system, a form in an e-commerce site...
- the given URL is the object that *handles* the posting

PUT requests that the enclosed object be stored under the given URL

DELETE deletes the given object

TRACE see RFC 2616, Section 9.8

CONNECT see RFC 2616, Section 9.8

Anatomy of a Response

```
HTTP/1.1 405 Method Not Allowed
Date: Fri, 18 Mar 2005 01:18:04 GMT
Server: Apache/2.0.46 (Red Hat)
Allow: GET,HEAD,POST,OPTIONS,TRACE
Content-Length: 329
Connection: close
Content-Type: text/html
```

```
<html><head>
<title>405 Method Not Allowed</title>
</head><body>
. . .
```

Anatomy of a Response

<pre>HTTP/1.1 405 Method Not Allowed Date: Fri, 18 Mar 2005 01:18:04 GMT Server: Apache/2.0.46 (Red Hat) Allow: GET,HEAD,POST,OPTIONS,TRACE Content-Length: 329 Connection: close Content-Type: text/html <html><head> <title>405 Method Not Allowed</title> </head><body> . . .</pre>	<p>status line</p>
-----------------------------------------------------------------------------------------------------------------------------------------------------------------------------------------------------------------------------------------------------------------------------------------------------------------------------	--------------------

Anatomy of a Response

<pre>HTTP/1.1 405 Method Not Allowed Date: Fri, 18 Mar 2005 01:18:04 GMT Server: Apache/2.0.46 (Red Hat) Allow: GET,HEAD,POST,OPTIONS,TRACE Content-Length: 329 Connection: close Content-Type: text/html <html><head> <title>405 Method Not Allowed</title> </head><body> . . .</pre>	<p>status line</p> <hr/> <p>zero or more header lines</p> <hr/> <hr/>
-----------------------------------------------------------------------------------------------------------------------------------------------------------------------------------------------------------------------------------------------------------------------------------------------------------------------------	---------------------------------------------------------------------------

Anatomy of a Response

HTTP/1.1 405 Method Not Allowed	status line
Date: Fri, 18 Mar 2005 01:18:04 GMT Server: Apache/2.0.46 (Red Hat) Allow: GET,HEAD,POST,OPTIONS,TRACE Content-Length: 329 Connection: close Content-Type: text/html	zero or more header lines
<html><head> <title>405 Method Not Allowed</title> </head><body> . . .	empty line

Anatomy of a Response

HTTP/1.1 405 Method Not Allowed	status line
Date: Fri, 18 Mar 2005 01:18:04 GMT Server: Apache/2.0.46 (Red Hat) Allow: GET,HEAD,POST,OPTIONS,TRACE Content-Length: 329 Connection: close Content-Type: text/html	zero or more header lines
	empty line
<html><head> <title>405 Method Not Allowed</title> </head><body> . . .	object body (possibly empty)

- Status line

HTTP/1.1 405 Method Not Allowed

- Status line

HTTP/1.1 405 Method Not Allowed
/ *version*

- Status line

HTTP/1.1 405 Method Not Allowed

version *status code*

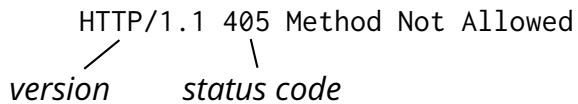

- Status line

HTTP/1.1 405 Method Not Allowed

version *status code* *brief description*

A diagram illustrating the components of an HTTP status line. The text "HTTP/1.1 405 Method Not Allowed" is shown in a monospaced font. Below it, three labels are positioned: "version" under "HTTP/1.1", "status code" under "405", and "brief description" under "Method Not Allowed". Three diagonal lines connect each label to its corresponding part of the status line.

- Status line

HTTP/1.1 405 Method Not Allowed

version *status code* *brief description*

The diagram illustrates the structure of an HTTP status line. The text 'HTTP/1.1 405 Method Not Allowed' is shown in a monospaced font. Three diagonal lines point downwards from the text to labels below: 'HTTP/1.1' points to 'version', '405' points to 'status code', and 'Method Not Allowed' points to 'brief description'. The labels are in an italicized font.

- The *status code* is a 3-digit value (e.g., 200 or 401)

- Status line

HTTP/1.1 405 Method Not Allowed

version *status code* *brief description*

The diagram illustrates the structure of an HTTP status line. The text 'HTTP/1.1 405 Method Not Allowed' is shown at the top. Three diagonal lines point downwards from the text to three labels below: 'version' points to 'HTTP/1.1', 'status code' points to '405', and 'brief description' points to 'Method Not Allowed'.

- The *status code* is a 3-digit value (e.g., 200 or 401)
- The rest has exactly the same structure as a request

1xx “informational” (see Section 10.1 of RFC 2616)

1xx “informational” (see Section 10.1 of RFC 2616)

2xx successful operation (see Section 10.2 of RFC 2616)

1xx “informational” (see Section 10.1 of RFC 2616)

2xx successful operation (see Section 10.2 of RFC 2616)

3xx redirection. E.g., indicates that the object has moved, either temporarily or permanently

1xx “informational” (see Section 10.1 of RFC 2616)

2xx successful operation (see Section 10.2 of RFC 2616)

3xx redirection. E.g., indicates that the object has moved, either temporarily or permanently

4xx client error. E.g., malformed request (400), object not found (404), method not allowed (405), unauthorized (401).

1xx “informational” (see Section 10.1 of RFC 2616)

2xx successful operation (see Section 10.2 of RFC 2616)

3xx redirection. E.g., indicates that the object has moved, either temporarily or permanently

4xx client error. E.g., malformed request (400), object not found (404), method not allowed (405), unauthorized (401).

5xx server error. E.g., internal server error (500), service overloaded (503)

- Object characterization
 - ▶ e.g., Content-Type, Content-Length, Content-Encoding

- Object characterization

- ▶ e.g., Content-Type, Content-Length, Content-Encoding

- Content negotiation

- ▶ e.g., Accept-Charset, Accept-Encoding

- Object characterization
 - ▶ e.g., Content-Type, Content-Length, Content-Encoding
- Content negotiation
 - ▶ e.g., Accept-Charset, Accept-Encoding
- Object properties useful for cache management
 - ▶ e.g., Expires, Last-Modified, ETag

- Object characterization
 - ▶ e.g., Content-Type, Content-Length, Content-Encoding
- Content negotiation
 - ▶ e.g., Accept-Charset, Accept-Encoding
- Object properties useful for cache management
 - ▶ e.g., Expires, Last-Modified, ETag
- Explicit cache control
 - ▶ e.g., Cache-Control

- Object characterization
 - ▶ e.g., Content-Type, Content-Length, Content-Encoding
- Content negotiation
 - ▶ e.g., Accept-Charset, Accept-Encoding
- Object properties useful for cache management
 - ▶ e.g., Expires, Last-Modified, ETag
- Explicit cache control
 - ▶ e.g., Cache-Control
- Method-specific responses
 - ▶ e.g., Allow as a response to OPTIONS

- Object characterization
 - ▶ e.g., Content-Type, Content-Length, Content-Encoding
- Content negotiation
 - ▶ e.g., Accept-Charset, Accept-Encoding
- Object properties useful for cache management
 - ▶ e.g., Expires, Last-Modified, ETag
- Explicit cache control
 - ▶ e.g., Cache-Control
- Method-specific responses
 - ▶ e.g., Allow as a response to OPTIONS
- Authorization/identification
 - ▶ e.g., Authorization

- Same idea as caching in a memory hierarchy



- Same idea as caching in a memory hierarchy

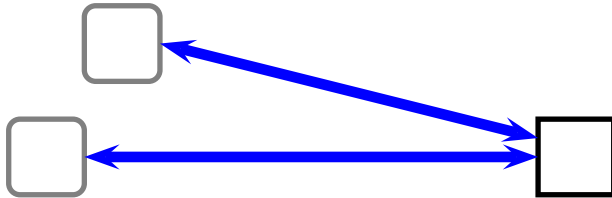

- Same idea as caching in a memory hierarchy

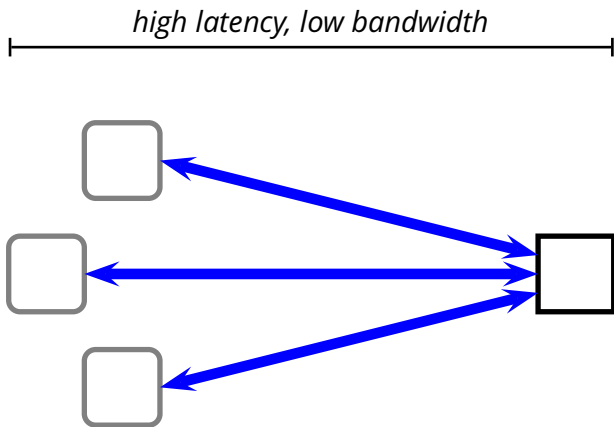

- Same idea as caching in a memory hierarchy

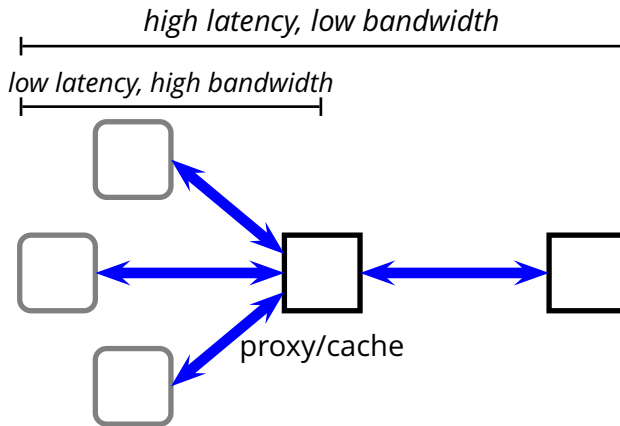

- Same idea as caching in a memory hierarchy

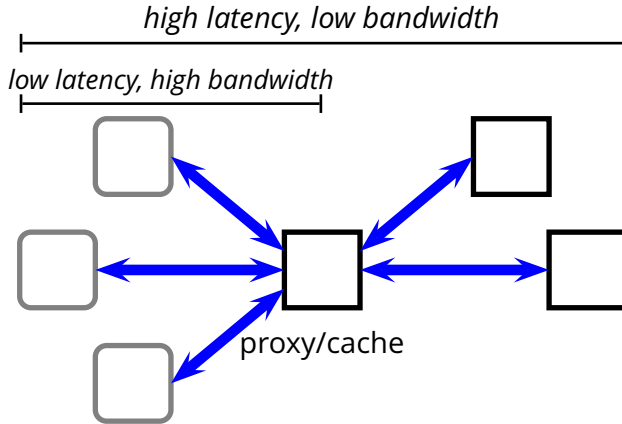

- Same idea as caching in a memory hierarchy

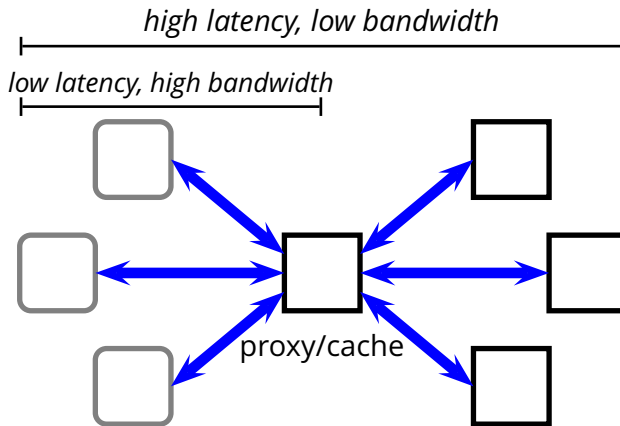



Example

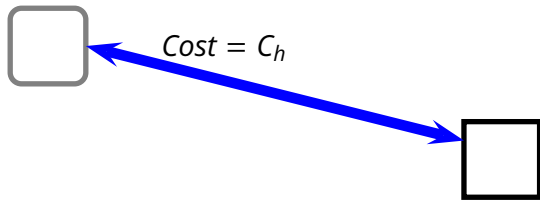

Example

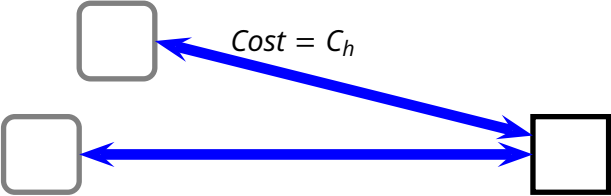

Example

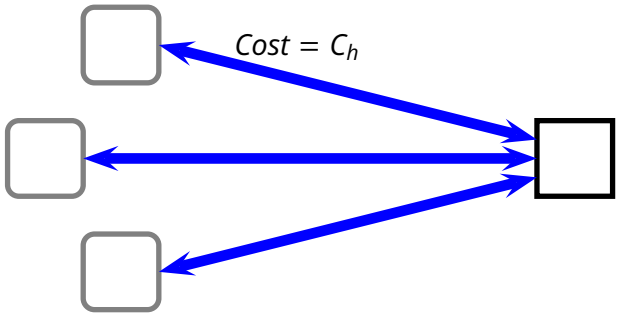



- Without proxy/cache: *total cost* = $3C_h$

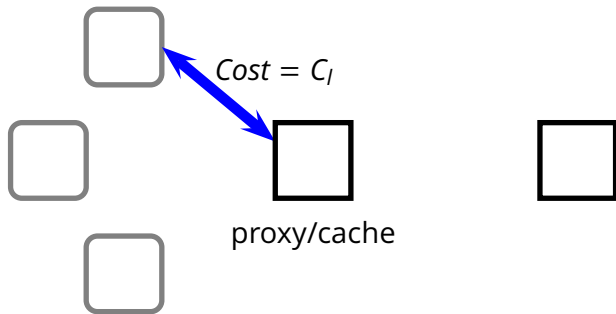

- Without proxy/cache: *total cost* = $3C_h$

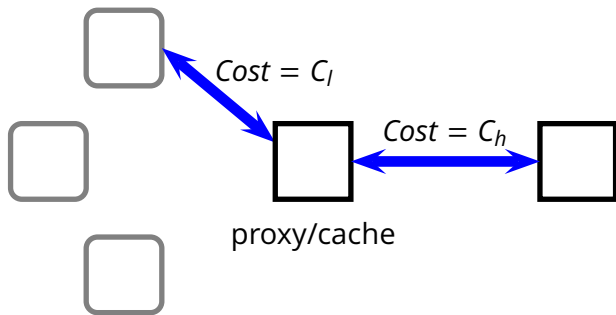

- Without proxy/cache: *total cost* = $3C_h$

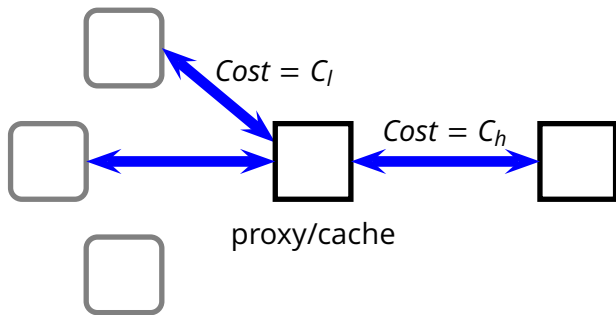

- Without proxy/cache: *total cost* = $3C_h$

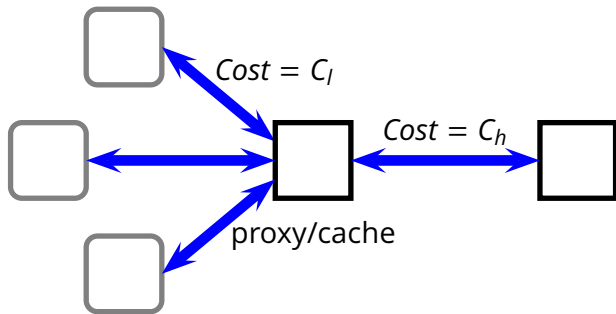

- Without proxy/cache: *total cost* = $3C_h$

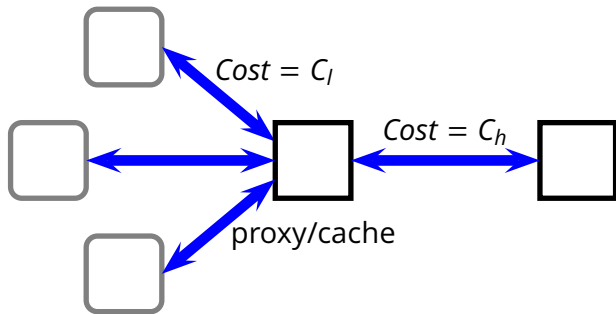

- Without proxy/cache: *total cost* = $3C_h$
- With proxy/cache: *total cost* = $C_h + 3C_l$

- A client request goes to a *proxy* (cache) server

- A client request goes to a *proxy* (cache) server
- The proxy may
 1. forward the request to the *origin* server, thereby acting as a client
 2. get the response from the origin server
 3. possibly store (cache) the object
 4. forward the response back to the client

- A client request goes to a *proxy* (cache) server
- The proxy may
 1. forward the request to the *origin* server, thereby acting as a client
 2. get the response from the origin server
 3. possibly store (cache) the object
 4. forward the response back to the client
- The proxy may
 1. respond immediately to the client, possibly using a cached object

- Benefits of the proxy/cache architecture

- Benefits of the proxy/cache architecture
 - ▶ performance: reduced latency

- Benefits of the proxy/cache architecture
 - ▶ performance: reduced latency
 - ▶ performance: reduced network traffic

- Benefits of the proxy/cache architecture
 - ▶ performance: reduced latency
 - ▶ performance: reduced network traffic
 - ▶ security: privacy, the server sees the proxy as a client

■ Benefits of the proxy/cache architecture

- ▶ performance: reduced latency
- ▶ performance: reduced network traffic
- ▶ security: privacy, the server sees the proxy as a client
- ▶ security: protection from intrusions, in combination with a firewall

■ Benefits of the proxy/cache architecture

- ▶ performance: reduced latency
- ▶ performance: reduced network traffic
- ▶ security: privacy, the server sees the proxy as a client
- ▶ security: protection from intrusions, in combination with a firewall

■ Problems

■ Benefits of the proxy/cache architecture

- ▶ performance: reduced latency
- ▶ performance: reduced network traffic
- ▶ security: privacy, the server sees the proxy as a client
- ▶ security: protection from intrusions, in combination with a firewall

■ Problems

- ▶ latency (just like any other caching system)
- ▶ complexity

- The proxy/cache architecture is central to several features of HTTP—in fact, *it affects its overall design*

- The proxy/cache architecture is central to several features of HTTP—in fact, *it affects its overall design*
- HTTP is defined as a request/response protocol, where requests and responses are explicitly passed through a ***request chain***

- The proxy/cache architecture is central to several features of HTTP—in fact, *it affects its overall design*
- HTTP is defined as a request/response protocol, where requests and responses are explicitly passed through a ***request chain***

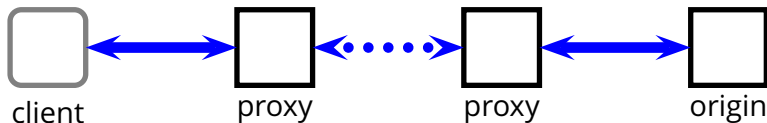

- HTTP is defined as a request/response protocol, where requests and responses are explicitly passed through a *request chain*

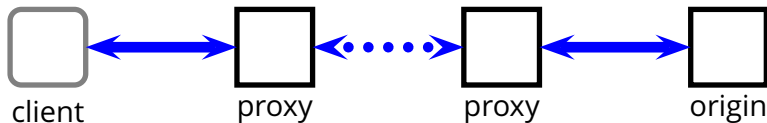

- HTTP defines

- HTTP is defined as a request/response protocol, where requests and responses are explicitly passed through a *request chain*

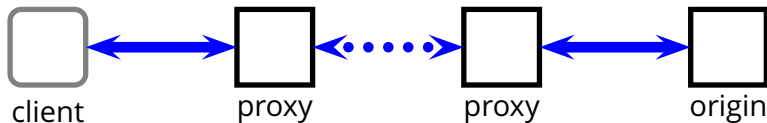

- HTTP defines
 - ▶ how protocol versions are handled on the request chain

- HTTP is defined as a request/response protocol, where requests and responses are explicitly passed through a *request chain*

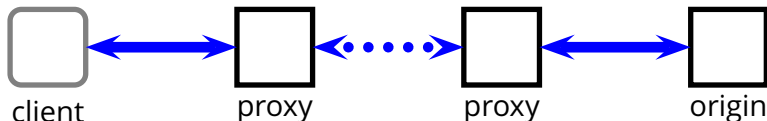

- HTTP defines
 - ▶ how protocol versions are handled on the request chain
 - ▶ how each method must be handled w.r.t. the request chain
 - ▶ e.g., responses to `OPTIONS` requests are not cacheable; `302` responses are only cacheable if indicated by a `Cache-Control` or `Expires` header field

- HTTP is defined as a request/response protocol, where requests and responses are explicitly passed through a *request chain*

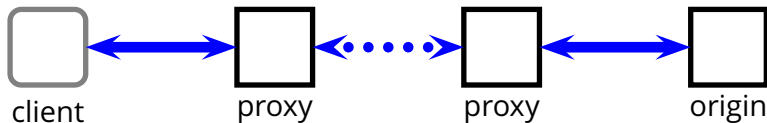

- HTTP defines
 - ▶ how protocol versions are handled on the request chain
 - ▶ how each method must be handled w.r.t. the request chain
 - ▶ e.g., responses to `OPTIONS` requests are not cacheable; `302` responses are only cacheable if indicated by a `Cache-Control` or `Expires` header field
 - ▶ specific authentication mechanisms for proxies

- HTTP is defined as a request/response protocol, where requests and responses are explicitly passed through a *request chain*

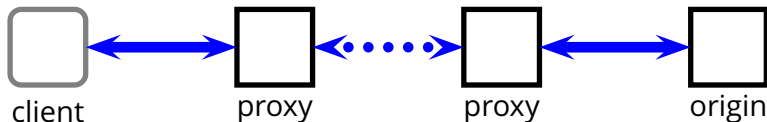

- HTTP defines
 - ▶ how protocol versions are handled on the request chain
 - ▶ how each method must be handled w.r.t. the request chain
 - ▶ e.g., responses to `OPTIONS` requests are not cacheable; `302` responses are only cacheable if indicated by a `Cache-Control` or `Expires` header field
 - ▶ specific authentication mechanisms for proxies
 - ▶ a lot of headers to control caching along the request chain

- Cached pages may become stale

- Cached pages may become stale
- A HEAD request could be used to see if an object has been updated, in which case the cache can be invalidated
 - ▶ but how does a proxy decide that it is okay to respond to a client with a cached object?

- Cached pages may become stale
- A HEAD request could be used to see if an object has been updated, in which case the cache can be invalidated
 - ▶ but how does a proxy decide that it is okay to respond to a client with a cached object?
- Servers specify explicit expiration times using either the Expires header, or the max-age directive of the Cache-Control header

- Cached pages may become stale
- A HEAD request could be used to see if an object has been updated, in which case the cache can be invalidated
 - ▶ but how does a proxy decide that it is okay to respond to a client with a cached object?
- Servers specify explicit expiration times using either the Expires header, or the max-age directive of the Cache-Control header
- A client or proxy can use a *conditional* GET by including a If-Modified-Since header

Cache-Control in Requests

- GET /carzaniga/index.html HTTP/1.1
Host: www.inf.usi.ch
Cache-Control: no-cache

- ```
GET /carzaniga/index.html HTTP/1.1
Host: www.inf.usi.ch
Cache-Control: no-cache
```

“Please, do not use cached objects!”

- ▶ proxies must go to the origin server

- ```
GET /carzaniga/index.html HTTP/1.1
Host: www.inf.usi.ch
Cache-Control: no-cache
```

“Please, do not use cached objects!”

- ▶ proxies must go to the origin server

- ```
GET /carzaniga/index.html HTTP/1.1
Host: www.inf.usi.ch
Cache-Control: max-age=20
```

- ```
GET /carzaniga/index.html HTTP/1.1
Host: www.inf.usi.ch
Cache-Control: no-cache
```

“Please, do not use cached objects!”

- ▶ proxies must go to the origin server

- ```
GET /carzaniga/index.html HTTP/1.1
Host: www.inf.usi.ch
Cache-Control: max-age=20
```

“Please, give me a cached object only if it is less than 20 seconds old”

# Cache-Control in Replies

- HTTP/1.1 200 Ok  
Cache-Control: no-cache  
...





```
HTTP/1.1 200 Ok
Cache-Control: no-cache

. . .
```

“Please, do not cache this objects!”

- HTTP/1.1 200 Ok  
Cache-Control: no-cache  
  
...

“Please, do not cache this objects!”

- HTTP/1.1 200 Ok  
Cache-Control: max-age=100; must-revalidate  
  
...

- HTTP/1.1 200 Ok  
Cache-Control: no-cache  
...

“Please, do not cache this objects!”

- HTTP/1.1 200 Ok  
Cache-Control: max-age=100; must-revalidate  
...

“You *may* use this object up to 100 seconds from now. After that, you *must* revalidate the object.”

- ▶ without the `must-revalidate` directive, a client may use a stale object



- HTTP is a stateless protocol

- HTTP is a stateless protocol
  - ▶ so how do you implement a “shopping cart”?

- HTTP is a stateless protocol
  - ▶ so how do you implement a “shopping cart”?
- HTTP provides the means for higher-level applications to maintain *stateful sessions* (see RFC 2109)

- HTTP is a stateless protocol
  - ▶ so how do you implement a “shopping cart”?
- HTTP provides the means for higher-level applications to maintain *stateful sessions* (see RFC 2109)
- Set-Cookie header
  - ▶ sent within an HTTP response, from the server to the client
  - ▶ tells the client to store the given “cookie” as a session identifier for that site



- HTTP is a stateless protocol
  - ▶ so how do you implement a “shopping cart”?
- HTTP provides the means for higher-level applications to maintain *stateful sessions* (see RFC 2109)
- Set-Cookie header
  - ▶ sent within an HTTP response, from the server to the client
  - ▶ tells the client to store the given “cookie” as a session identifier for that site
- Cookie header
  - ▶ sent within an HTTP request, from the client to the server
  - ▶ tells the server that the request belongs to the given session

web  
browser  
*hispeed.ch*

web  
server  
*blah.com*





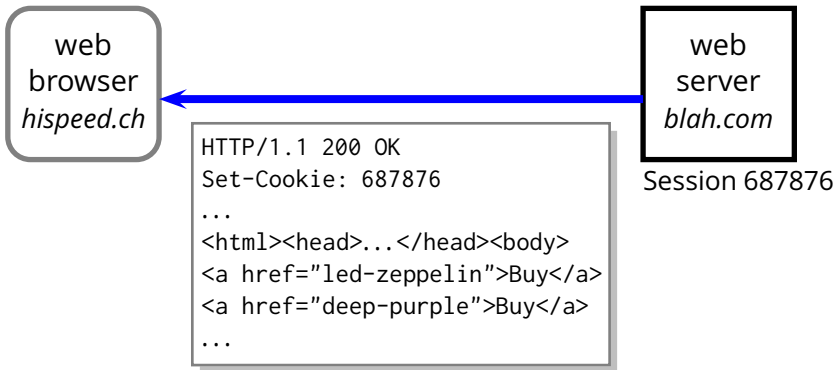

# Example

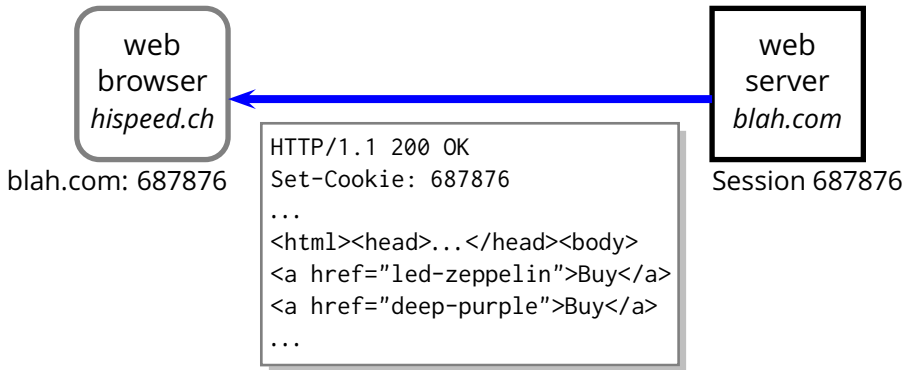



blah.com: 687876



Session 687876

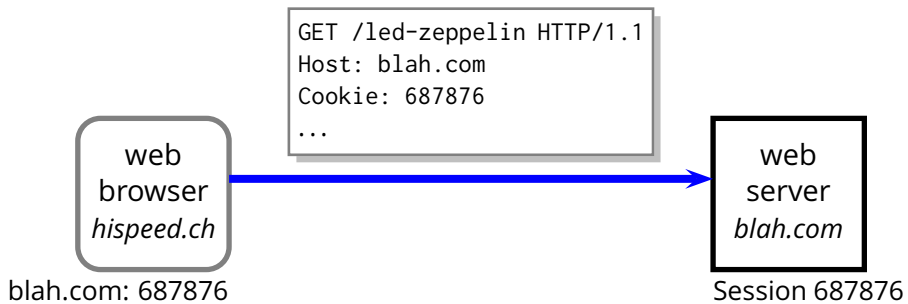





blah.com: 687876



Session 687876  
Led Zeppelin

# Example

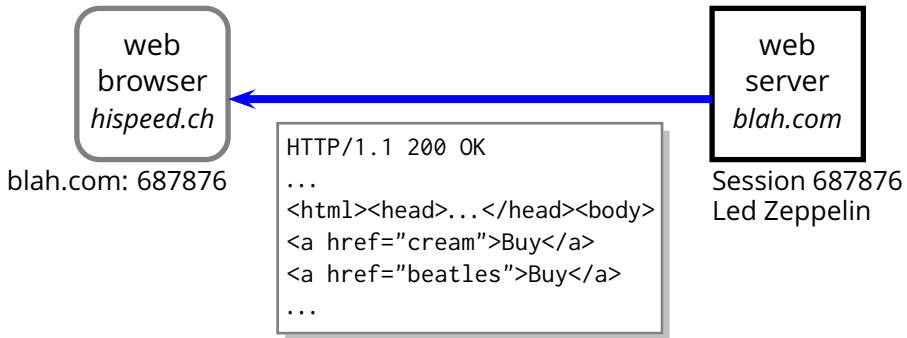



blah.com: 687876



Session 687876  
Led Zeppelin

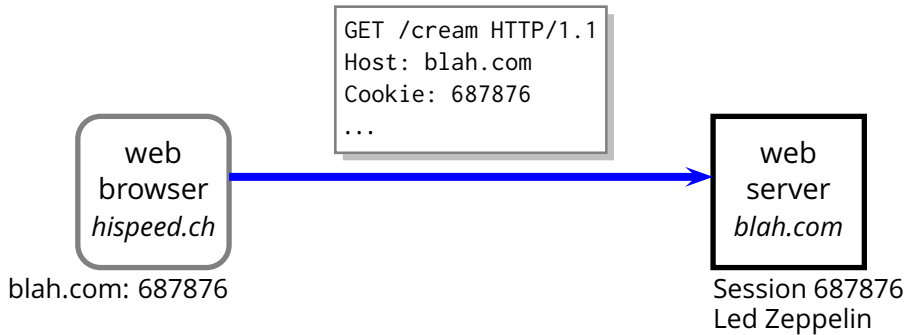



blah.com: 687876



Session 687876  
Led Zeppelin  
Cream

# Example





blah.com: 687876



Session 687876  
Led Zeppelin  
Cream

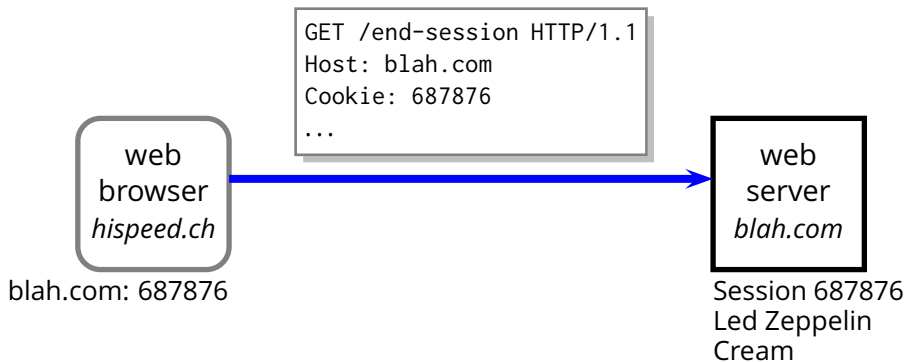





blah.com: 687876



Session 687876  
Led Zeppelin  
Cream

# Example

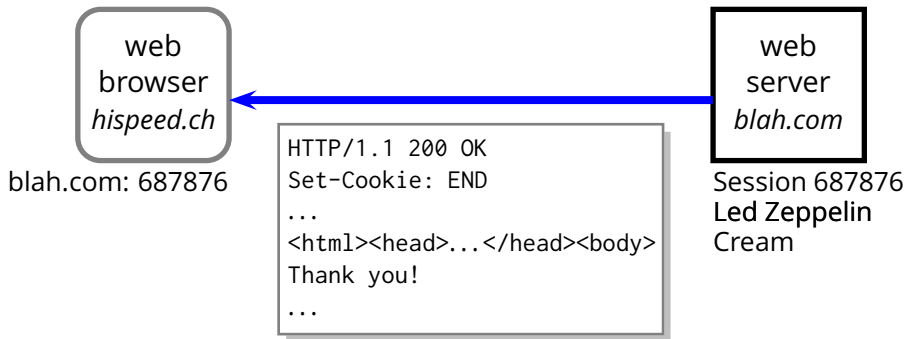

web  
browser  
*hispeed.ch*

blah.com: END

web  
server  
*blah.com*

Session 687876  
Led Zeppelin  
Cream

- A “session” identifies the actions of a user

- A “session” identifies the actions of a user
- Web sites may use cookies to compile and collect user profiles
  - ▶ and obviously they do exactly that!

- A “session” identifies the actions of a user
- Web sites may use cookies to compile and collect user profiles
  - ▶ and obviously they do exactly that!
- In our example, we can infer that user n. 687876...

- A “session” identifies the actions of a user
- Web sites may use cookies to compile and collect user profiles
  - ▶ and obviously they do exactly that!
- In our example, we can infer that user n. 687876...
  - ▶ likes rock-blues music from the sixties and seventies

- A “session” identifies the actions of a user
- Web sites may use cookies to compile and collect user profiles
  - ▶ and obviously they do exactly that!
- In our example, we can infer that user n. 687876...
  - ▶ likes rock-blues music from the sixties and seventies
  - ▶ lives in Switzerland



- A “session” identifies the actions of a user
- Web sites may use cookies to compile and collect user profiles
  - ▶ and obviously they do exactly that!
- In our example, we can infer that user n. 687876...
  - ▶ likes rock-blues music from the sixties and seventies
  - ▶ lives in Switzerland
  - ▶ ...

- A “session” identifies the actions of a user
- Web sites may use cookies to compile and collect user profiles
  - ▶ and obviously they do exactly that!
- In our example, we can infer that user n. 687876...
  - ▶ likes rock-blues music from the sixties and seventies
  - ▶ lives in Switzerland
  - ▶ ...
- If user n. 687876 buys something on line with a credit card, then he or she would also be immediately indentified