

# Basic Concepts In Computer Networking

Antonio Carzaniga

Faculty of Informatics  
Università della Svizzera italiana

February 19, 2020

# Goal of this Lecture

- Understand what *packet switching* is
- Understand what *circuit switching* is
- Understand their differences
- Understand what a *protocol* is

- What is the Internet?
- Types of network
- Types of service
- Protocols
- The Internet protocol stack



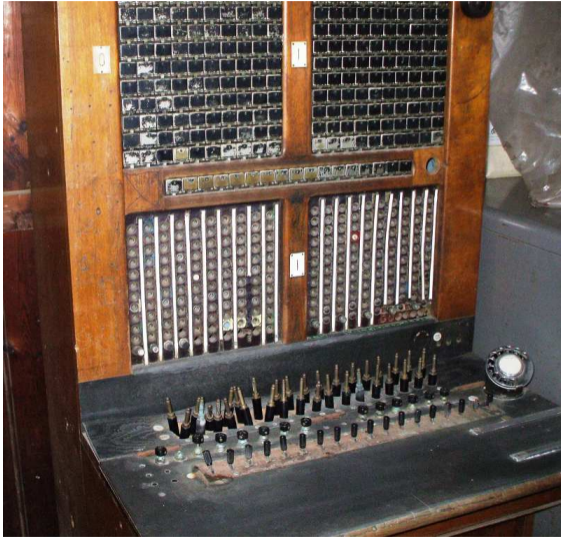

# What is the Internet?

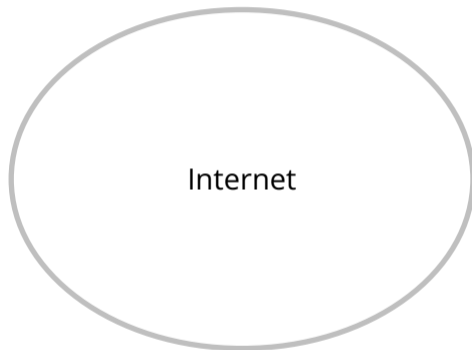

# What is the Internet?

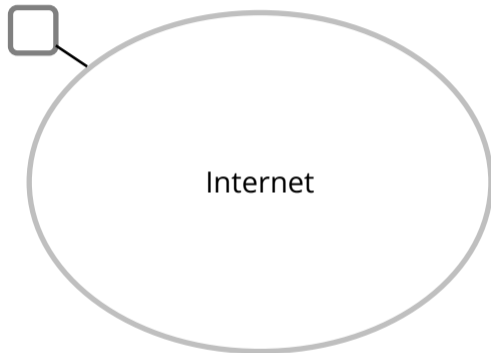

# What is the Internet?

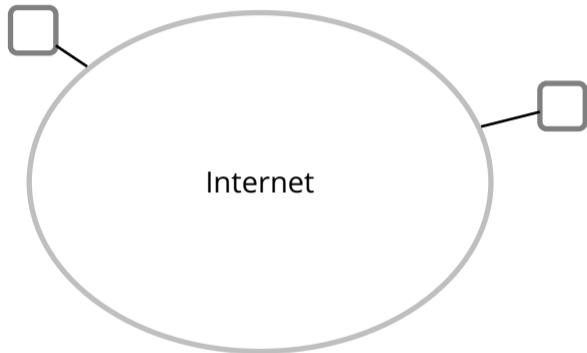



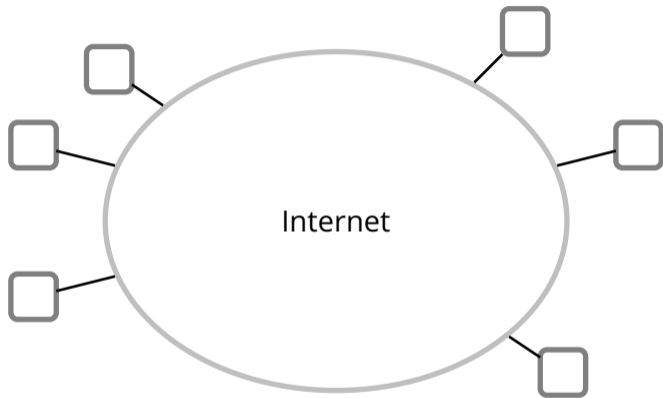

# What is the Internet?

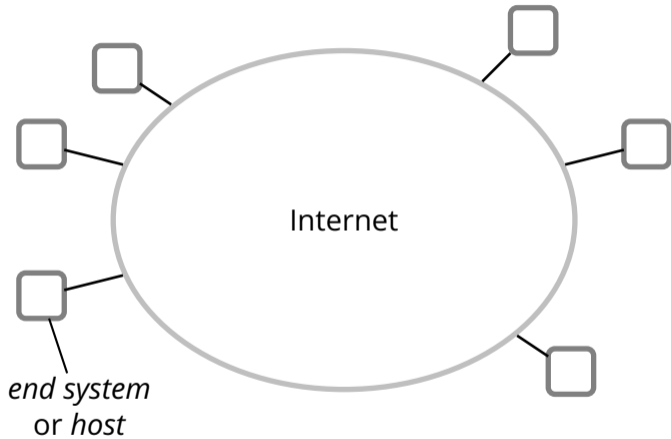

# What is the Internet?



- *End system* or *host* ()

- ***End system*** or ***host*** ()
  - ▶ a computer

■ **End system** or **host** ()

- ▶ a computer
- ▶ a phone (more or less “smart”)

## ■ *End system* or *host* ()

- ▶ a computer
- ▶ a phone (more or less “smart”)
- ▶ a server (well, that would also be a computer)

## ■ *End system* or *host* ()

- ▶ a computer
- ▶ a phone (more or less “smart”)
- ▶ a server (well, that would also be a computer)
- ▶ a camera (a.k.a., webcam)

## ■ *End system* or *host* (□)

- ▶ a computer
- ▶ a phone (more or less “smart”)
- ▶ a server (well, that would also be a computer)
- ▶ a camera (a.k.a., webcam)
- ▶ a temperature sensor



## ■ *End system* or *host* (□)

- ▶ a computer
- ▶ a phone (more or less “smart”)
- ▶ a server (well, that would also be a computer)
- ▶ a camera (a.k.a., webcam)
- ▶ a temperature sensor
- ▶ a light bulb

## ■ *End system* or *host* ()

- ▶ a computer
- ▶ a phone (more or less “smart”)
- ▶ a server (well, that would also be a computer)
- ▶ a camera (a.k.a., webcam)
- ▶ a temperature sensor
- ▶ a light bulb
- ▶ ...
- ▶ a car
- ▶ a television set
- ▶ a picture frame
- ▶ a toaster
- ▶ ...

## ■ *End system* or *host* (□)

- ▶ a computer
- ▶ a phone (more or less “smart”)
- ▶ a server (well, that would also be a computer)
- ▶ a camera (a.k.a., webcam)
- ▶ a temperature sensor
- ▶ a light bulb
- ▶ ...
- ▶ a car
- ▶ a television set
- ▶ a picture frame
- ▶ a toaster
- ▶ ...
- ▶ a toilet seat?
- ▶ a toothpick?
- ▶ ...

## What is *Inside* the Internet?

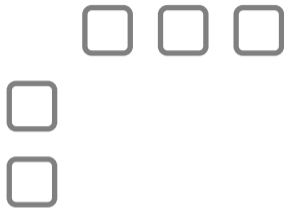

## What is *Inside* the Internet?

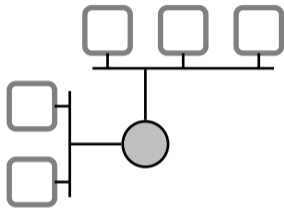

# What is *Inside* the Internet?

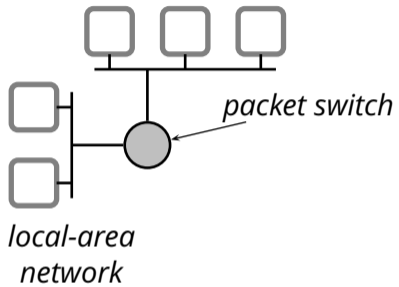

# What is *Inside* the Internet?

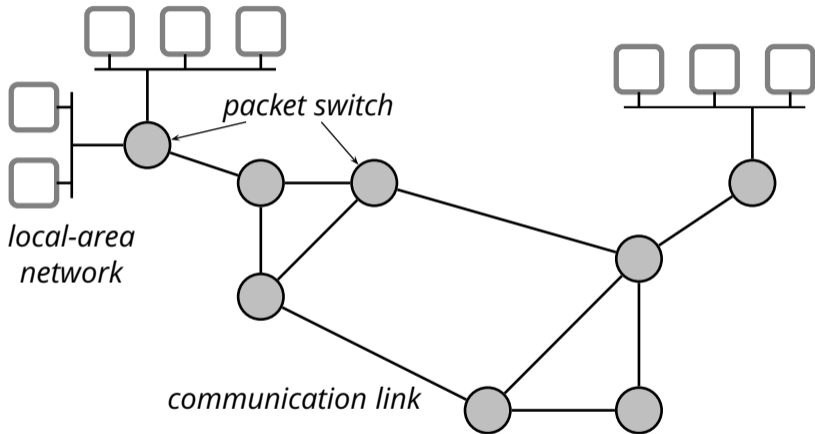

- The Internet uses *packet switching*



- The Internet uses *packet switching*
- *Packet switch*: a *link-layer switch* or a *router*

- The Internet uses ***packet switching***
- ***Packet switch:*** a *link-layer switch* or a ***router***
- ***Communication link:*** a connection between packet switches and/or end systems

- The Internet uses ***packet switching***
- ***Packet switch:*** a *link-layer switch* or a ***router***
- ***Communication link:*** a connection between packet switches and/or end systems
- ***Route:*** sequence of switches that a packet goes through (a.k.a. *path*)

- The Internet uses ***packet switching***
- ***Packet switch***: a *link-layer switch* or a ***router***
- ***Communication link***: a connection between packet switches and/or end systems
- ***Route***: sequence of switches that a packet goes through (a.k.a. *path*)
- ***Protocol***: control the sending and receiving of information to and from end systems and packet switches

- Various types and forms of medium

## ■ Various types and forms of medium

- ▶ Fiber-optic cable
- ▶ Twisted-pair copper wire
- ▶ Coaxial cable
- ▶ Wireless local-area links (e.g., 802.11, Bluetooth)
- ▶ Satellite channel
- ▶ ...

# Packet Switching

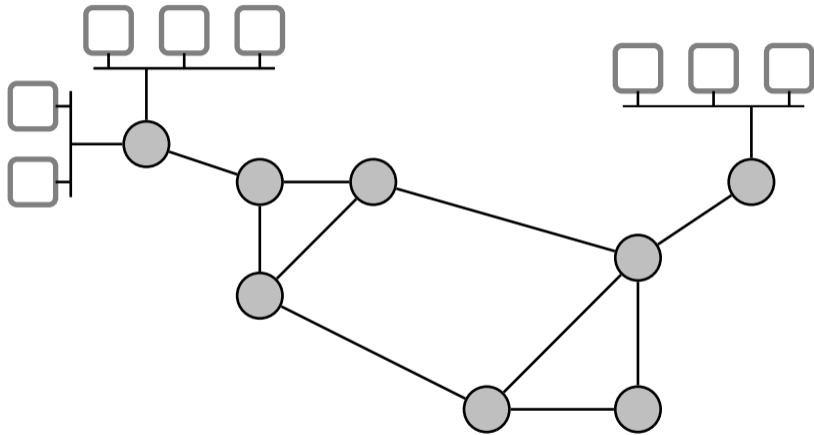

# Packet Switching

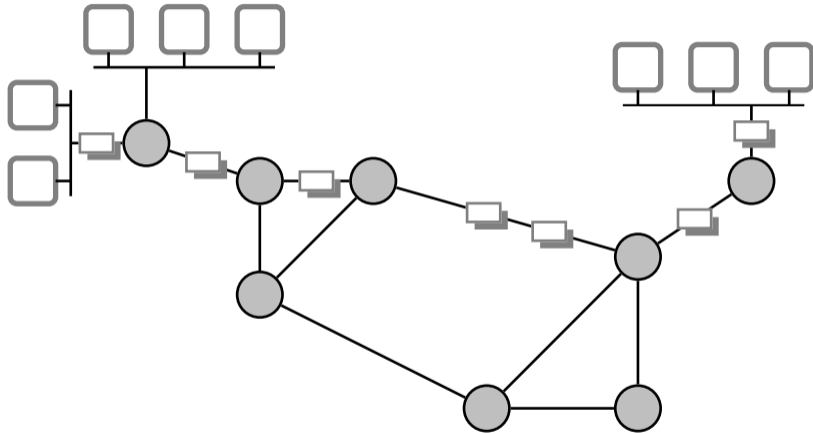



# Packet Switching

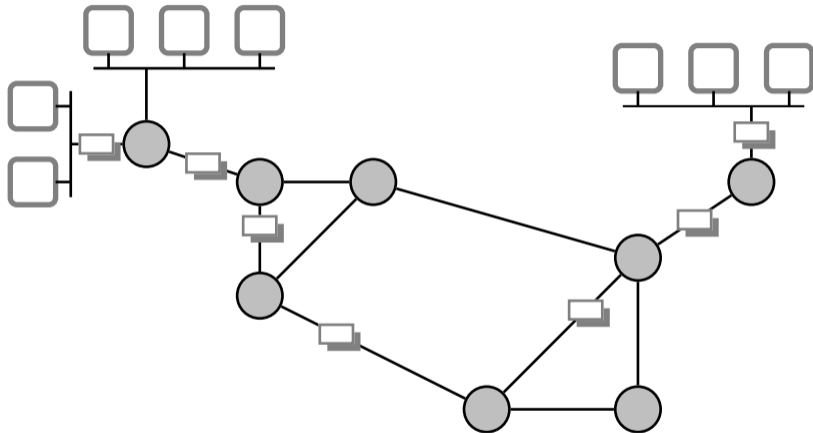

- The Internet is a *packet-switched* network

- The Internet is a *packet-switched* network
- Information is transmitted in *packets*

- The Internet is a *packet-switched* network
- Information is transmitted in *packets*
- Switches operate on individual packets

- The Internet is a *packet-switched* network
- Information is transmitted in *packets*
- Switches operate on individual packets
- A switch (router) receives packets and *forwards* them along to other switches or to end systems

- The Internet is a *packet-switched* network
- Information is transmitted in *packets*
- Switches operate on individual packets
- A switch (router) receives packets and *forwards* them along to other switches or to end systems
- Every forwarding decision is taken on the basis of the information contained in the packet

# Circuit Switching

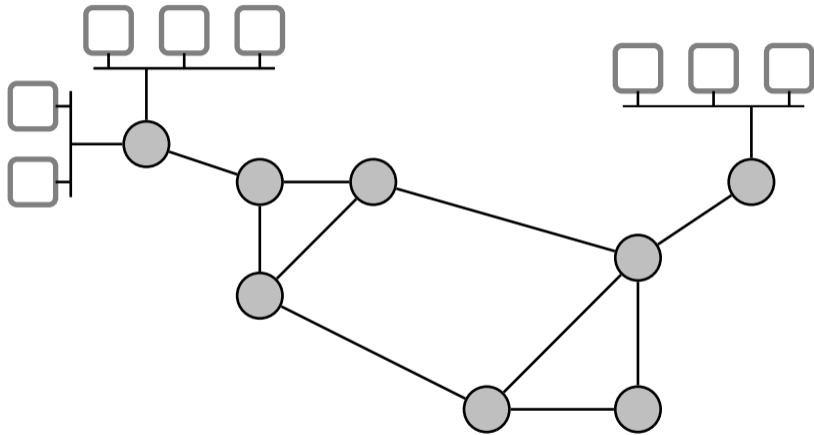

# Circuit Switching

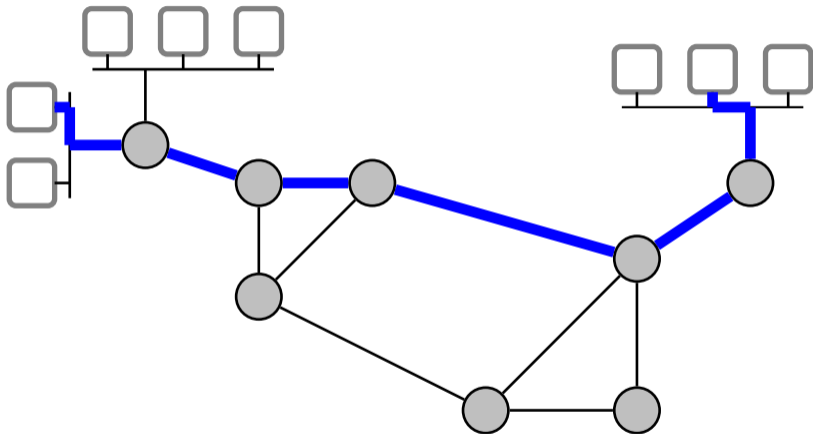



- The telephone network is a typical circuit-switched network
  - ▶ not any more, really, but still...

- The telephone network is a typical circuit-switched network
  - ▶ not any more, really, but still...
- Communication requires a ***connection setup*** phase in which the network reserves all the necessary resources for that connection (links, buffers, switches, etc.)

- The telephone network is a typical circuit-switched network
  - ▶ not any more, really, but still...
- Communication requires a **connection setup** phase in which the network reserves all the necessary resources for that connection (links, buffers, switches, etc.)
- After a successful setup, the communicating systems are connected by **a set of links dedicated to the connection** for the entire duration of their conversation

- The telephone network is a typical circuit-switched network
  - ▶ not any more, really, but still...
- Communication requires a **connection setup** phase in which the network reserves all the necessary resources for that connection (links, buffers, switches, etc.)
- After a successful setup, the communicating systems are connected by **a set of links dedicated to the connection** for the entire duration of their conversation
- When the conversation ends, the network tears down the connection, freeing the corresponding resources (links, buffers, etc.) for other connections

# Circuit vs. Packet Switching

# Circuit vs. Packet Switching



# Circuit vs. Packet Switching

- Circuit switching requires an expensive setup phase
  - ▶ however, once the connection is established, little or no processing is required

# Circuit vs. Packet Switching

- Circuit switching requires an expensive setup phase
  - ▶ however, once the connection is established, little or no processing is required
- Packet switching does not incur any setup cost
  - ▶ however, it always incurs a significant processing and space overhead, on a per-packet basis
    - ▶ *processing cost* for forwarding
    - ▶ *space overhead* because every packet must be self-contained



## Circuit vs. Packet Switching (2)

## Circuit vs. Packet Switching (2)

- Circuit switching admits a straightforward implementation of quality-of-service guarantees
  - ▶ network resources are reserved at connection setup time

## Circuit vs. Packet Switching (2)

- Circuit switching admits a straightforward implementation of quality-of-service guarantees
  - ▶ network resources are reserved at connection setup time
- Guaranteeing any quality of service with packet switching is very difficult
  - ▶ no concept of a “connection”
  - ▶ and again, processing, space overhead, etc.

## Circuit vs. Packet Switching (3)

- Circuit switching allows only a limited sharing of communication resources
  - ▶ once a connection is established, the resources are blocked even though there might be long silence periods
  - ▶ i.e., circuit switching is an inefficient way to use the network

## Circuit vs. Packet Switching (3)

- Circuit switching allows only a limited sharing of communication resources
  - ▶ once a connection is established, the resources are blocked even though there might be long silence periods
  - ▶ i.e., circuit switching is an inefficient way to use the network
- Packet switching achieves a much better utilization of network resources
  - ▶ it is designed specifically to share links
  - ▶ it is designed specifically to share links

- Idea: combine the advantages of circuit switching and packet switching

- Idea: combine the advantages of circuit switching and packet switching
- There is a connection setup phase

- Idea: combine the advantages of circuit switching and packet switching
- There is a connection setup phase
- The connection does not create a physical circuit, but rather a “virtual circuit”



- Idea: combine the advantages of circuit switching and packet switching
- There is a connection setup phase
- The connection does not create a physical circuit, but rather a “virtual circuit”
- Information is sent in packets, so links can be shared more effectively

- Idea: combine the advantages of circuit switching and packet switching
- There is a connection setup phase
- The connection does not create a physical circuit, but rather a “virtual circuit”
- Information is sent in packets, so links can be shared more effectively
- Packets carry a *virtual circuit identifier* instead of the destination address

- Idea: combine the advantages of circuit switching and packet switching
- There is a connection setup phase
- The connection does not create a physical circuit, but rather a “virtual circuit”
- Information is sent in packets, so links can be shared more effectively
- Packets carry a *virtual circuit identifier* instead of the destination address
  - ▶ *Important observation:* at any given time there are much fewer *connections* than *destinations*
    - ▶ much faster per-packet processing (forwarding)
    - ▶ lower per-packet space overhead

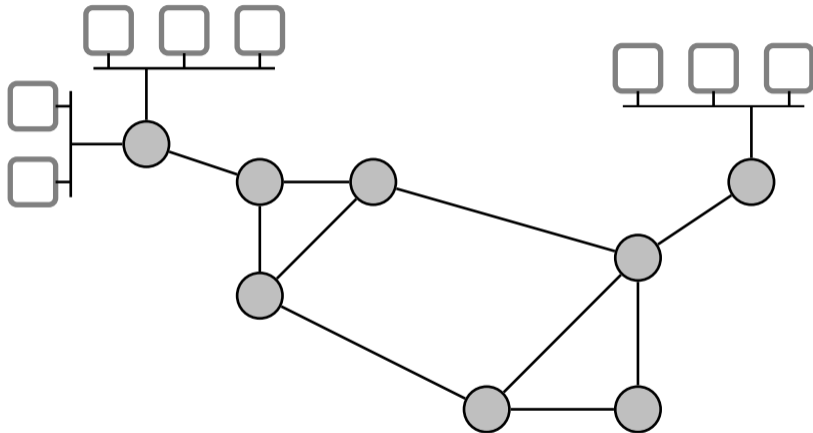

# Virtual Circuit

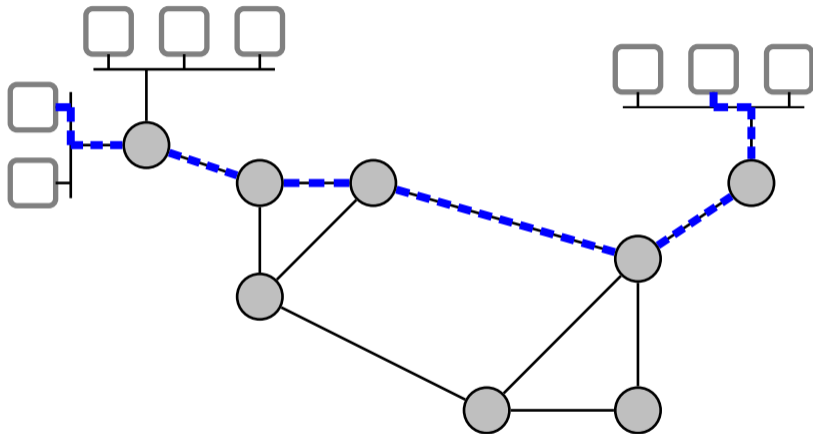

# Virtual Circuit

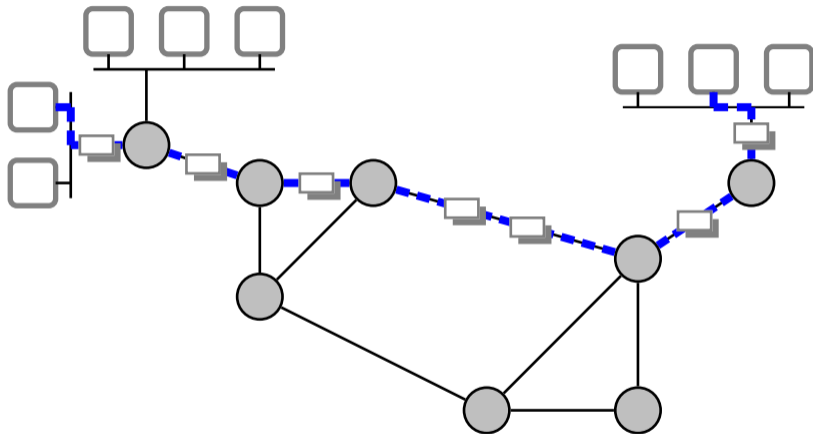

# Taxonomy of Networks

communication  
network

# Taxonomy of Networks

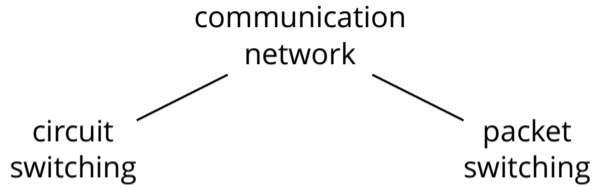



# Taxonomy of Networks

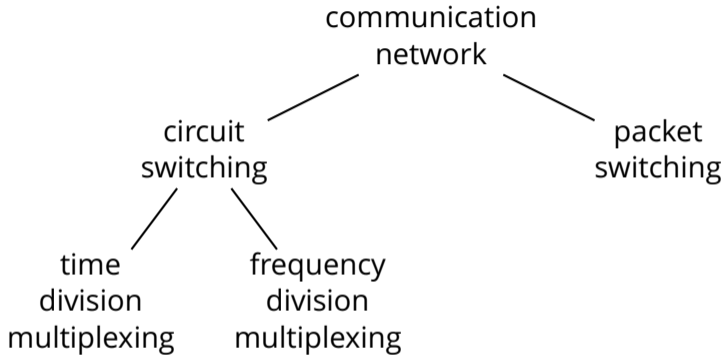

# Taxonomy of Networks

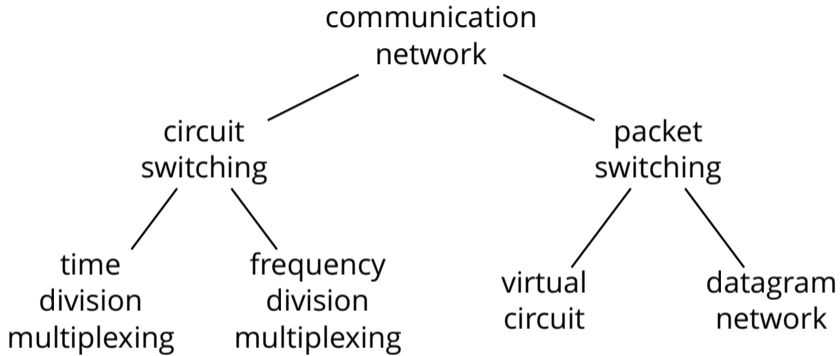

# Taxonomy of Networks

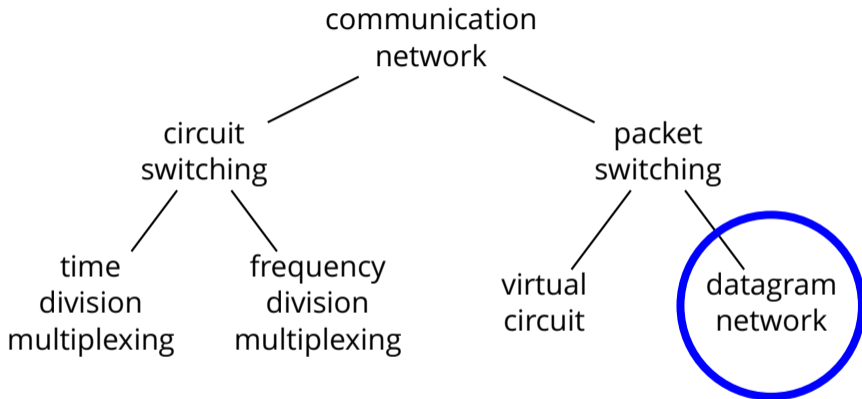

# Service Perspective

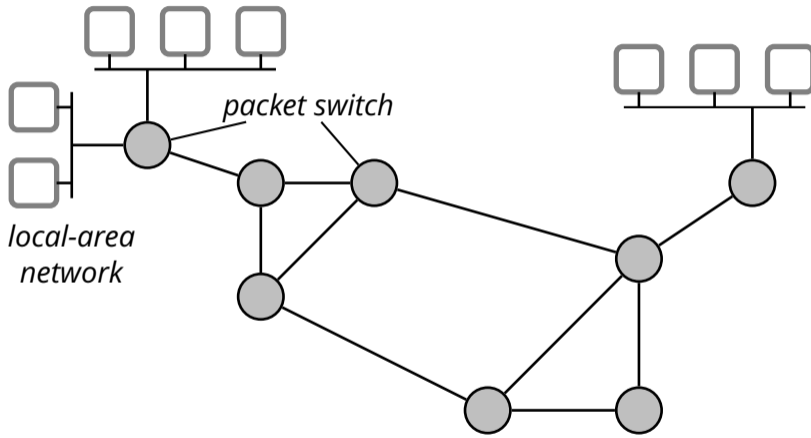

# Service Perspective

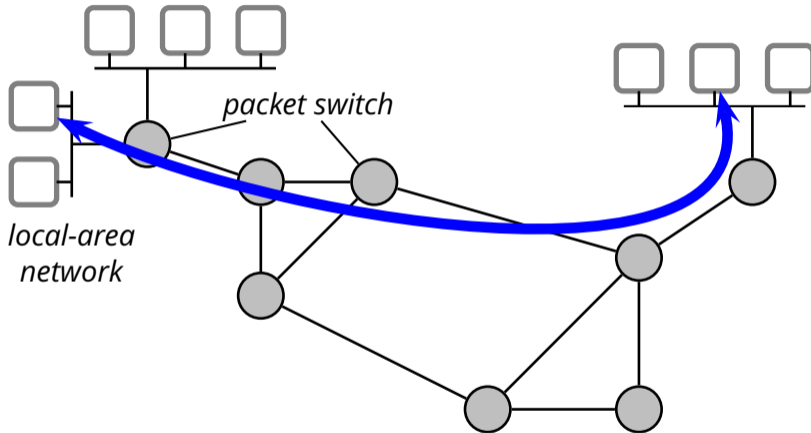

- What kind of *service* does the Internet offer to end systems?

- Two end systems can communicate through the Internet, but exactly what kind of communication service is that of the Internet?

- Two end systems can communicate through the Internet, but exactly what kind of communication service is that of the Internet?
- **Connectionless, “best effort”**
  - ▶ the network accepts “datagrams” for delivery—this is conceptually similar to the postal service
  - ▶ “best effort” really means *unreliable* though not malicious

- Two end systems can communicate through the Internet, but exactly what kind of communication service is that of the Internet?
- **Connectionless, “best effort”**
  - ▶ the network accepts “datagrams” for delivery—this is conceptually similar to the postal service
  - ▶ “best effort” really means *unreliable* though not malicious
- **Connection-oriented, reliable**
  - ▶ virtual duplex communication channel ( $A \leftrightarrow B$ )—conceptually similar to a telephone service
  - ▶ information is transmitted “reliably” and in order



- How reliable is a “reliable” service?

- How reliable is a “reliable” service?
- The term “reliable” means that information will eventually reach its destination if a route is viable within a certain amount of time

- How reliable is a “reliable” service?
- The term “reliable” means that information will eventually reach its destination if a route is viable within a certain amount of time
- The network makes absolutely no guarantees on *latency* (i.e., the time it takes to transmit some information from a source to a destination)

# Communication Protocols

- End systems as well as packet switches run *protocols*. What is a protocol?

# Communication Protocols

- End systems as well as packet switches run *protocols*. What is a protocol?  
E.g., let's consider a phone call: Alice calls Bob

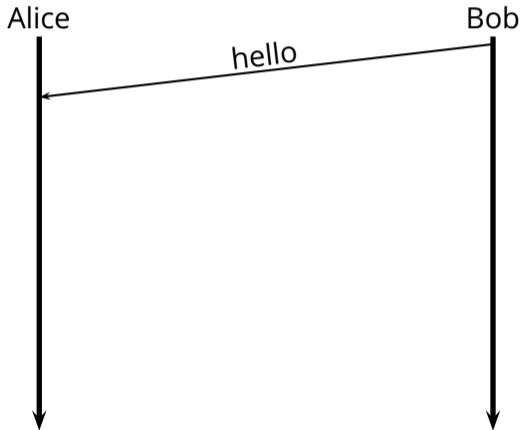

# Communication Protocols

- End systems as well as packet switches run *protocols*. What is a protocol?  
E.g., let's consider a phone call: Alice calls Bob

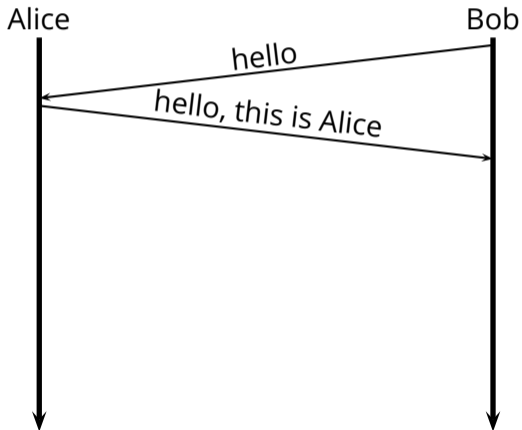

# Communication Protocols

- End systems as well as packet switches run *protocols*. What is a protocol?  
E.g., let's consider a phone call: Alice calls Bob

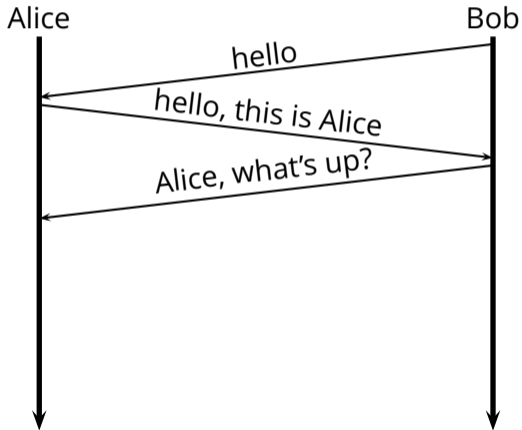

- End systems as well as packet switches run *protocols*. What is a protocol?  
E.g., let's consider a phone call: Alice calls Bob

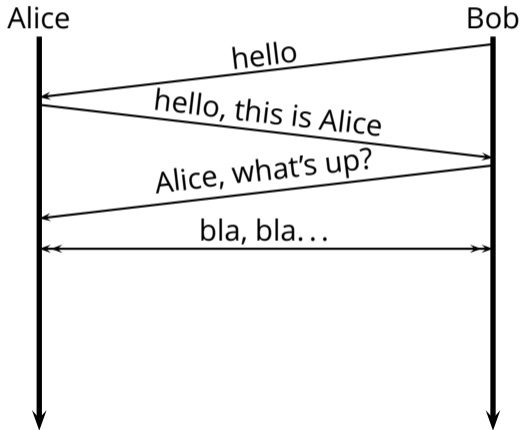



# Communication Protocols

- End systems as well as packet switches run *protocols*. What is a protocol?  
E.g., let's consider a phone call: Alice calls Bob

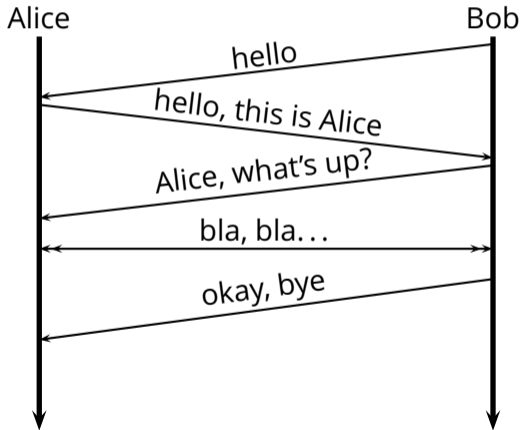

- End systems as well as packet switches run *protocols*. What is a protocol?  
E.g., let's consider a phone call: Alice calls Bob

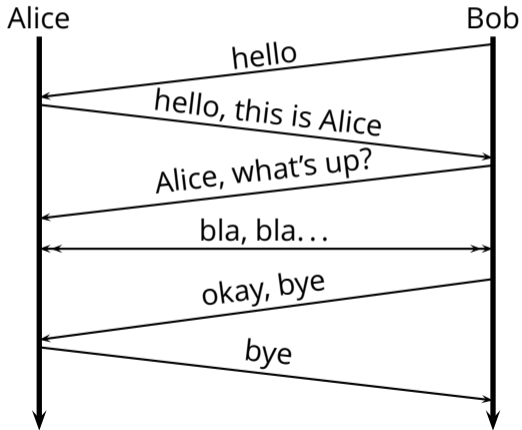

## ■ Phases of the protocol

- ▶ *handshake*: establishes the identities and/or the context
- ▶ *conversation*: free-form exchange
- ▶ *closing*: terminates the conversation

- Phases of the protocol
  - ▶ *handshake*: establishes the identities and/or the context
  - ▶ *conversation*: free-form exchange
  - ▶ *closing*: terminates the conversation
- This protocol assumes a connection-oriented medium
- The protocol involves two parties (Alice and Bob)
- ...

- Another example: air traffic control

- Another example: air traffic control
  - ▶ ...United 971, turn left heading 2-7-0

- Another example: air traffic control
  - ▶ ...United 971, turn left heading 2-7-0
  - ▶ left to 2-7-0, United 971

- Another example: air traffic control
  - ▶ ...United 971, turn left heading 2-7-0
  - ▶ left to 2-7-0, United 971
  - ▶ ...Alitalia 631, contact Malpensa approach at 119.20



- Another example: air traffic control
  - ▶ ...United 971, turn left heading 2-7-0
  - ▶ left to 2-7-0, United 971
  - ▶ ...Alitalia 631, contact Malpensa approach at 119.20
  - ▶ ...

- Another example: air traffic control
  - ▶ ...United 971, turn left heading 2-7-0
  - ▶ left to 2-7-0, United 971
  - ▶ ...Alitalia 631, contact Malpensa approach at 119.20
  - ▶ ...
  - ▶ ...Alitalia 631, contact Malpensa approach at 119.20

### ■ Another example: air traffic control

- ▶ ...United 971, turn left heading 2-7-0
- ▶ left to 2-7-0, United 971
- ▶ ...Alitalia 631, contact Malpensa approach at 119.20
- ▶ ...
- ▶ ...Alitalia 631, contact Malpensa approach at 119.20
- ▶ 1-1-9 point 2-0, Alitalia 631, ciao

### ■ Another example: air traffic control

- ▶ ...United 971, turn left heading 2-7-0
- ▶ left to 2-7-0, United 971
- ▶ ...Alitalia 631, contact Malpensa approach at 119.20
- ▶ ...
- ▶ ...Alitalia 631, contact Malpensa approach at 119.20
- ▶ 1-1-9 point 2-0, Alitalia 631, ciao
- ▶ ...Center, request, Delta 800

### ■ Another example: air traffic control

- ▶ ...United 971, turn left heading 2-7-0
- ▶ left to 2-7-0, United 971
- ▶ ...Alitalia 631, contact Malpensa approach at 119.20
- ▶ ...
- ▶ ...Alitalia 631, contact Malpensa approach at 119.20
- ▶ 1-1-9 point 2-0, Alitalia 631, ciao
- ▶ ...Center, request, Delta 800
- ▶ ...United 971, climb and maintain flight level 3-7-0

### ■ Another example: air traffic control

- ▶ ... United 971, turn left heading 2-7-0
- ▶ left to 2-7-0, United 971
- ▶ ... Alitalia 631, contact Malpensa approach at 119.20
- ▶ ...
- ▶ ... Alitalia 631, contact Malpensa approach at 119.20
- ▶ 1-1-9 point 2-0, Alitalia 631, ciao
- ▶ ... Center, request, Delta 800
- ▶ ... United 971, climb and maintain flight level 3-7-0
- ▶ flight level 3-7-0, United 971

### ■ Another example: air traffic control

- ▶ ... United 971, turn left heading 2-7-0
- ▶ left to 2-7-0, United 971
- ▶ ... Alitalia 631, contact Malpensa approach at 119.20
- ▶ ...
- ▶ ... Alitalia 631, contact Malpensa approach at 119.20
- ▶ 1-1-9 point 2-0, Alitalia 631, ciao
- ▶ ... Center, request, Delta 800
- ▶ ... United 971, climb and maintain flight level 3-7-0
- ▶ flight level 3-7-0, United 971
- ▶ ... Delta 800, go ahead

### ■ Another example: air traffic control

- ▶ ... United 971, turn left heading 2-7-0
- ▶ left to 2-7-0, United 971
- ▶ ... Alitalia 631, contact Malpensa approach at 119.20
- ▶ ...
- ▶ ... Alitalia 631, contact Malpensa approach at 119.20
- ▶ 1-1-9 point 2-0, Alitalia 631, ciao
- ▶ ... Center, request, Delta 800
- ▶ ... United 971, climb and maintain flight level 3-7-0
- ▶ flight level 3-7-0, United 971
- ▶ ... Delta 800, go ahead
- ▶ requesting flight level 3-5-0, Delta 800



### ■ Another example: air traffic control

- ▶ ... United 971, turn left heading 2-7-0
- ▶ left to 2-7-0, United 971
- ▶ ... Alitalia 631, contact Malpensa approach at 119.20
- ▶ ...
- ▶ ... Alitalia 631, contact Malpensa approach at 119.20
- ▶ 1-1-9 point 2-0, Alitalia 631, ciao
- ▶ ... Center, request, Delta 800
- ▶ ... United 971, climb and maintain flight level 3-7-0
- ▶ flight level 3-7-0, United 971
- ▶ ... Delta 800, go ahead
- ▶ requesting flight level 3-5-0, Delta 800
- ▶ Delta 800, unable at the moment

# Communication Protocols (2)

- A connectionless protocol

## Communication Protocols (2)

- A connectionless protocol
- Multi-party communication

## Communication Protocols (2)

- A connectionless protocol
- Multi-party communication
- Medium access control (MAC) protocol

## Communication Protocols (2)

- A connectionless protocol
- Multi-party communication
- Medium access control (MAC) protocol
- Interleaved communication

## Communication Protocols (2)

- A connectionless protocol
- Multi-party communication
- Medium access control (MAC) protocol
- Interleaved communication
- Acknowledgements

## Communication Protocols (2)

- A connectionless protocol
- Multi-party communication
- Medium access control (MAC) protocol
- Interleaved communication
- Acknowledgements
- Timeout and retransmission



## Communication Protocols (2)

- A connectionless protocol
- Multi-party communication
- Medium access control (MAC) protocol
- Interleaved communication
- Acknowledgements
- Timeout and retransmission
- "Master" role

# Communication Protocols (3)

- Let's revisit the phone-call protocol

Alice



Bob



- Let's revisit the phone-call protocol

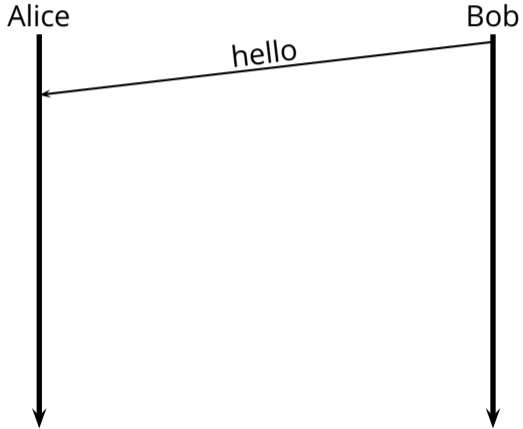

- Let's revisit the phone-call protocol

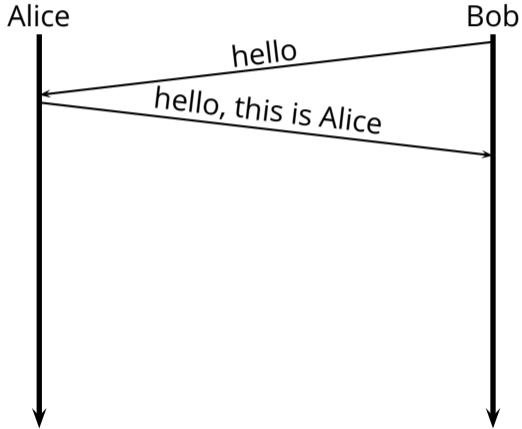

# Communication Protocols (3)

- Let's revisit the phone-call protocol

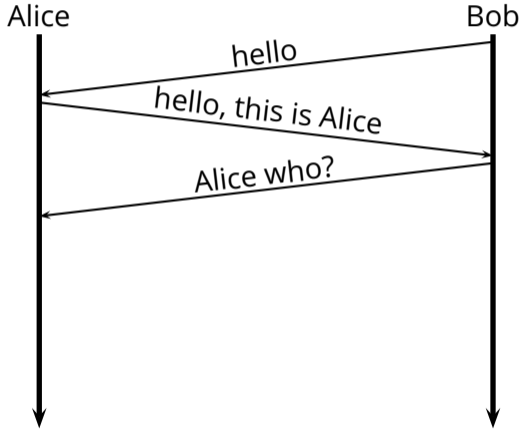

- Let's revisit the phone-call protocol

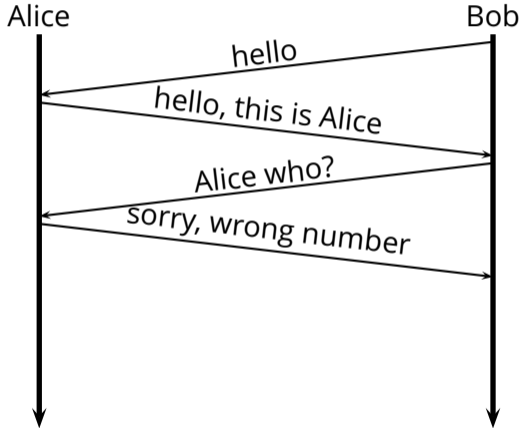

# Communication Protocols (4)

- Another run of the phone-call protocol

Alice



Bob



- Another run of the phone-call protocol

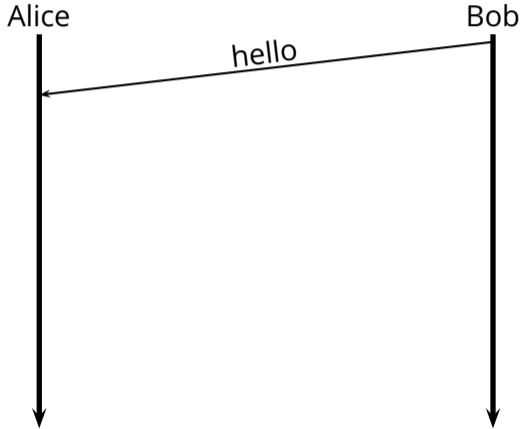



- Another run of the phone-call protocol

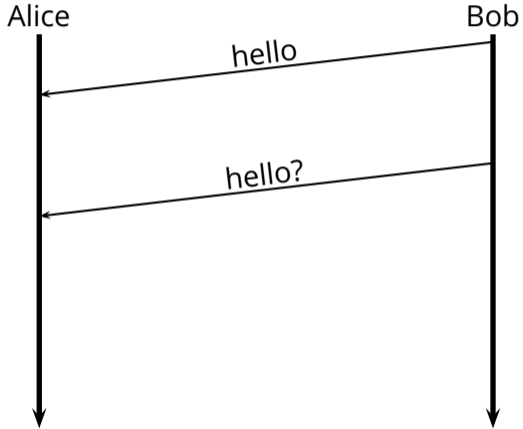

- Another run of the phone-call protocol

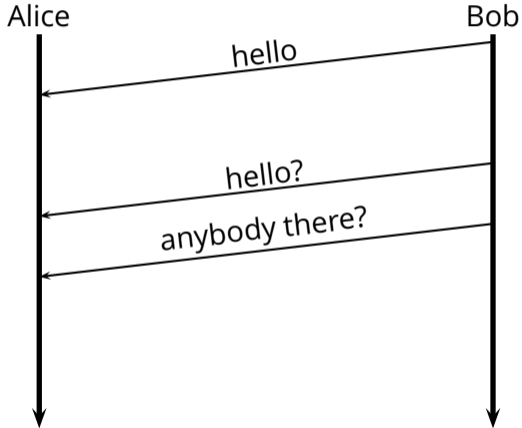

# Communication Protocols: Principles

- A protocol is a lot like a program
  - ▶ in fact, it is a *distributed program*, where different processes can send messages to each other

# Communication Protocols: Principles

- A protocol is a lot like a program
  - ▶ in fact, it is a *distributed program*, where different processes can send messages to each other
- It is an *executable* specification

# Communication Protocols: Principles

- A protocol is a lot like a program
  - ▶ in fact, it is a *distributed program*, where different processes can send messages to each other
- It is an *executable* specification
- It must be *unambiguous*

# Communication Protocols: Principles

- A protocol is a lot like a program
  - ▶ in fact, it is a *distributed program*, where different processes can send messages to each other
- It is an *executable* specification
- It must be *unambiguous*
- It must be *complete*
  - ▶ i.e., it must include actions and/or responses for all possible situations and all possible messages

# Communication Protocols: Principles

- A protocol is a lot like a program
  - ▶ in fact, it is a *distributed program*, where different processes can send messages to each other
- It is an *executable* specification
- It must be *unambiguous*
- It must be *complete*
  - ▶ i.e., it must include actions and/or responses for all possible situations and all possible messages
- A network protocol must also define all the necessary *message formats*

- Another protocol: deciding where to go for dinner



- Another protocol: deciding where to go for dinner

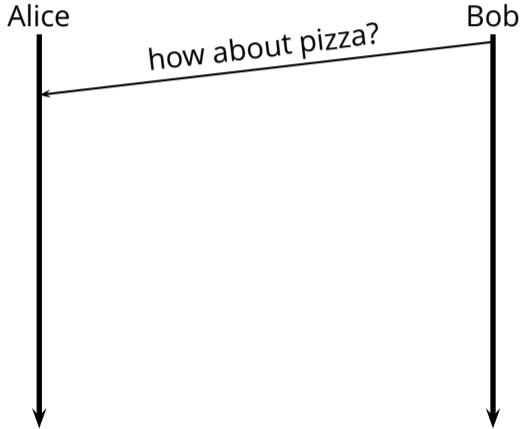

- Another protocol: deciding where to go for dinner

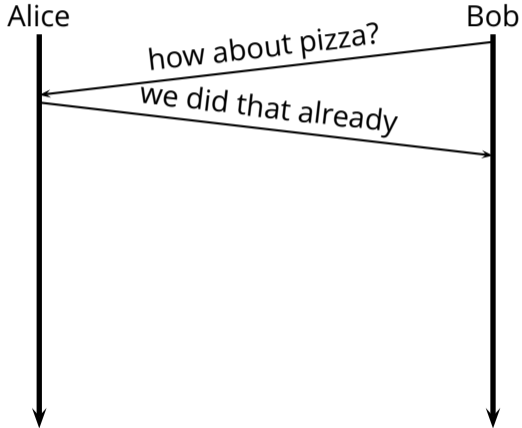

## Communication Protocols (5)

- Another protocol: deciding where to go for dinner

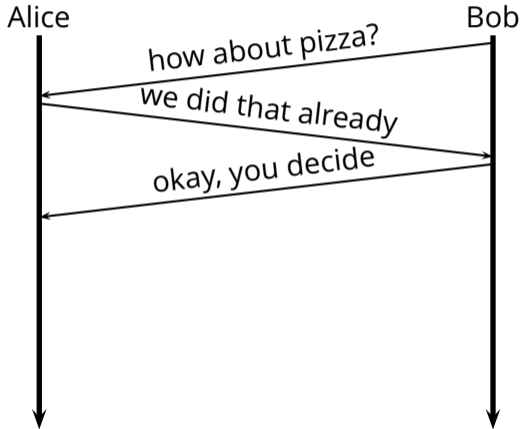

- Another protocol: deciding where to go for dinner

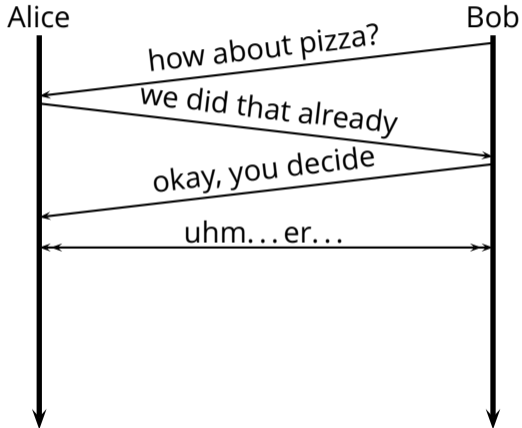

## Communication Protocols (5)

- Another protocol: deciding where to go for dinner

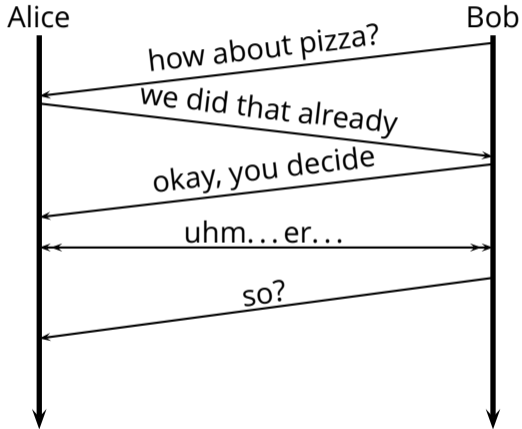

- Another protocol: deciding where to go for dinner

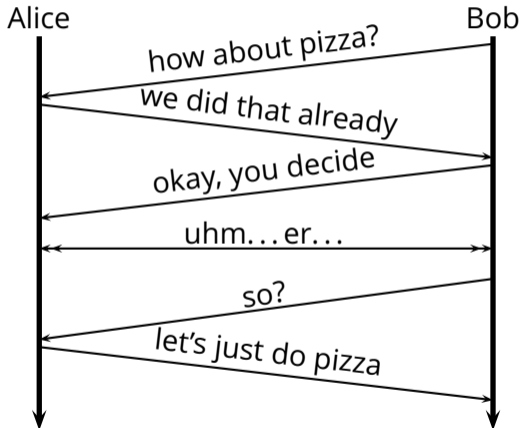

- Alice calls Bob to decide where to go for dinner

- Alice calls Bob to decide where to go for dinner

Alice



Bob





- Alice calls Bob to decide where to go for dinner

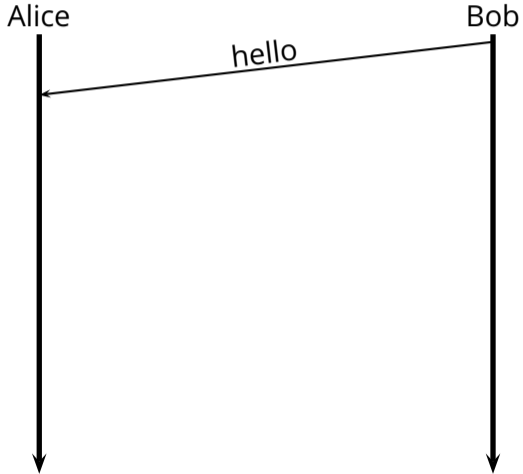

- Alice calls Bob to decide where to go for dinner

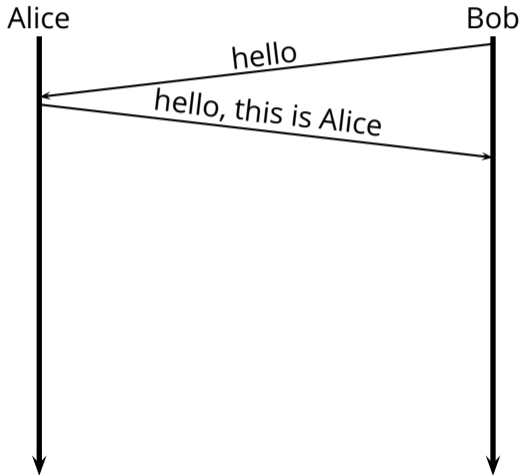

- Alice calls Bob to decide where to go for dinner

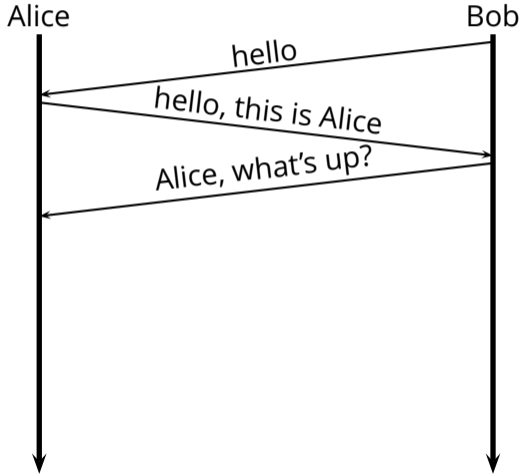

- Alice calls Bob to decide where to go for dinner

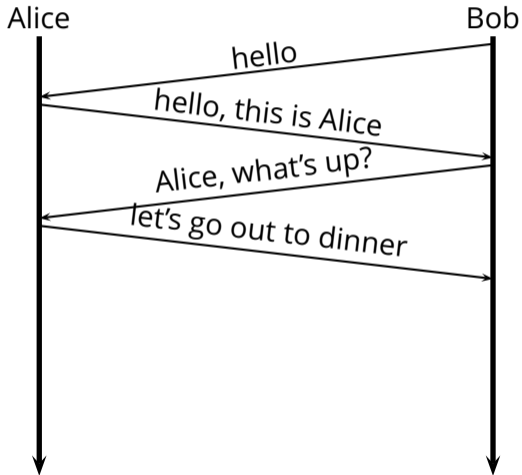

- Alice calls Bob to decide where to go for dinner

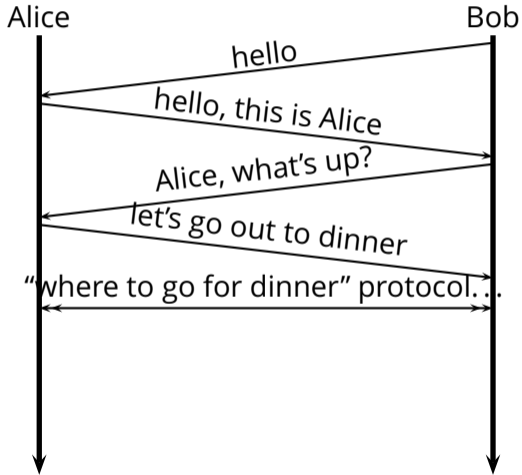

- Alice calls Bob to decide where to go for dinner

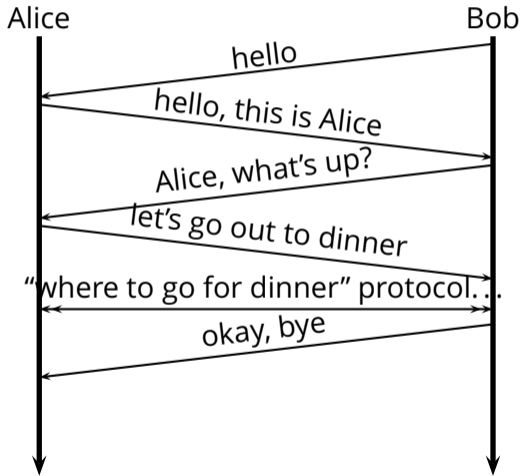

- Alice calls Bob to decide where to go for dinner

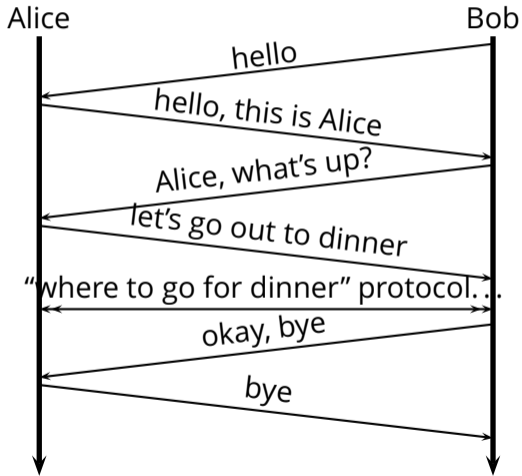

- Alice calls Bob to decide where to go for dinner



- Alice calls Bob to decide where to go for dinner

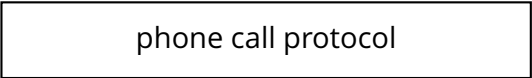

phone call protocol

- Alice calls Bob to decide where to go for dinner

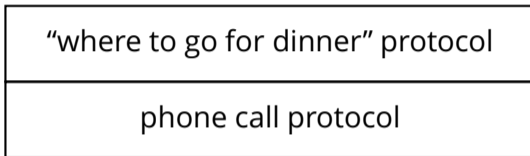

- Alice calls Bob to decide where to go for dinner

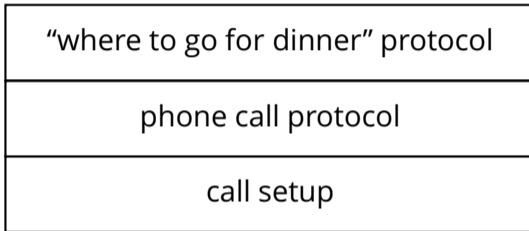

- Alice calls Bob to decide where to go for dinner

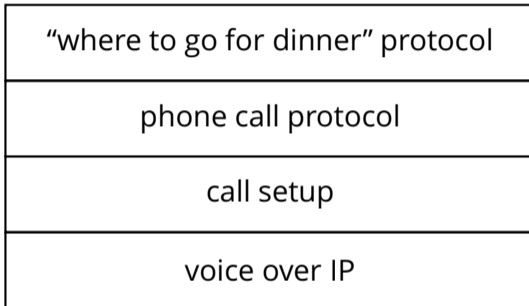

- Alice calls Bob to decide where to go for dinner

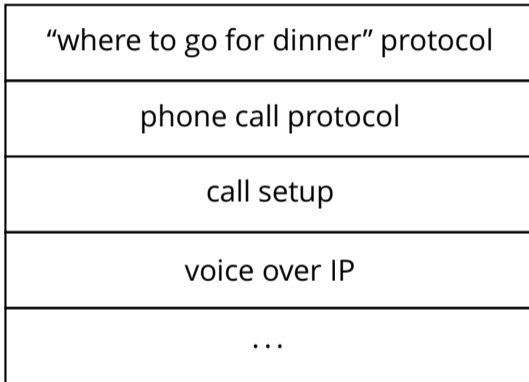

# Internet Protocol Stack

# Internet Protocol Stack



application

# Internet Protocol Stack

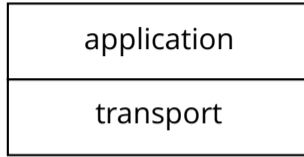



# Internet Protocol Stack

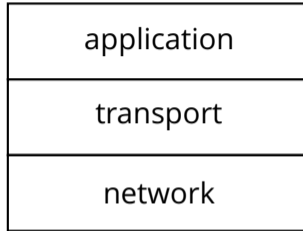

# Internet Protocol Stack

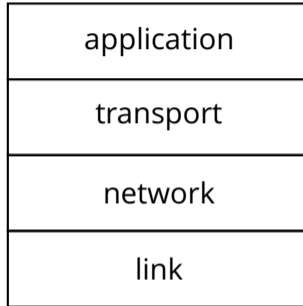

# Internet Protocol Stack

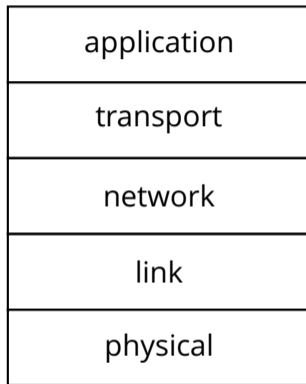

- *Application* (e.g., HTTP, SMTP, and DNS)
  - ▶ application functionalities
  - ▶ application messages

- *Application* (e.g., HTTP, SMTP, and DNS)
  - ▶ application functionalities
  - ▶ application messages
- *Transport* (e.g., TCP and UDP)
  - ▶ application multiplexing, reliable transfer (TCP), congestion control (TCP)
  - ▶ datagrams (UDP) or segments (TCP)

- *Application* (e.g., HTTP, SMTP, and DNS)
  - ▶ application functionalities
  - ▶ application messages
- *Transport* (e.g., TCP and UDP)
  - ▶ application multiplexing, reliable transfer (TCP), congestion control (TCP)
  - ▶ datagrams (UDP) or segments (TCP)
- *Network* (IP)
  - ▶ end to end datagram, best-effort service, routing, fragmentation
  - ▶ packets (IP)

- *Application* (e.g., HTTP, SMTP, and DNS)
  - ▶ application functionalities
  - ▶ application messages
- *Transport* (e.g., TCP and UDP)
  - ▶ application multiplexing, reliable transfer (TCP), congestion control (TCP)
  - ▶ datagrams (UDP) or segments (TCP)
- *Network* (IP)
  - ▶ end to end datagram, best-effort service, routing, fragmentation
  - ▶ packets (IP)
- *Link* (e.g., Ethernet and PPP)
  - ▶ point-to-point or local broadcast communication
  - ▶ frames (or packets)

- *Application* (e.g., HTTP, SMTP, and DNS)
  - ▶ application functionalities
  - ▶ application messages
- *Transport* (e.g., TCP and UDP)
  - ▶ application multiplexing, reliable transfer (TCP), congestion control (TCP)
  - ▶ datagrams (UDP) or segments (TCP)
- *Network* (IP)
  - ▶ end to end datagram, best-effort service, routing, fragmentation
  - ▶ packets (IP)
- *Link* (e.g., Ethernet and PPP)
  - ▶ point-to-point or local broadcast communication
  - ▶ frames (or packets)
- *Physical*