

# **Graphs: Representation and Elementary Algorithms**

Antonio Carzaniga

Faculty of Informatics  
Università della Svizzera italiana

May 2, 2024

- Graphs: definitions
- Representations
- Breadth-first search
- Depth-first search

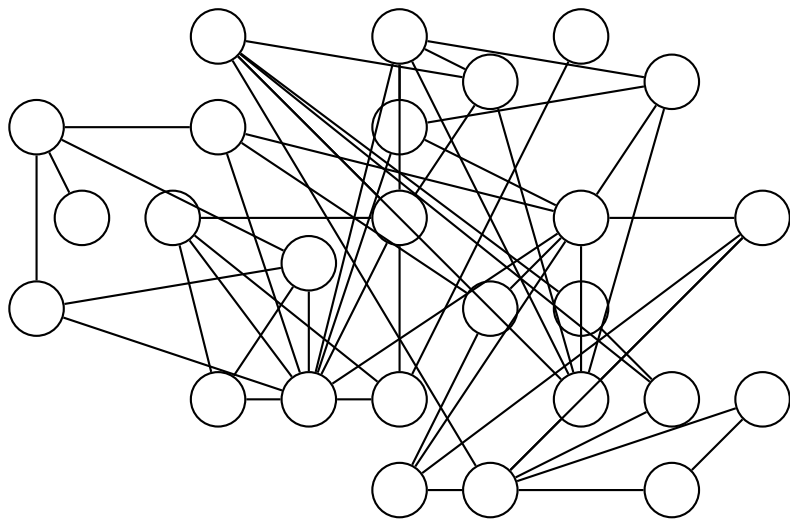



## Same Example (Better Layout)

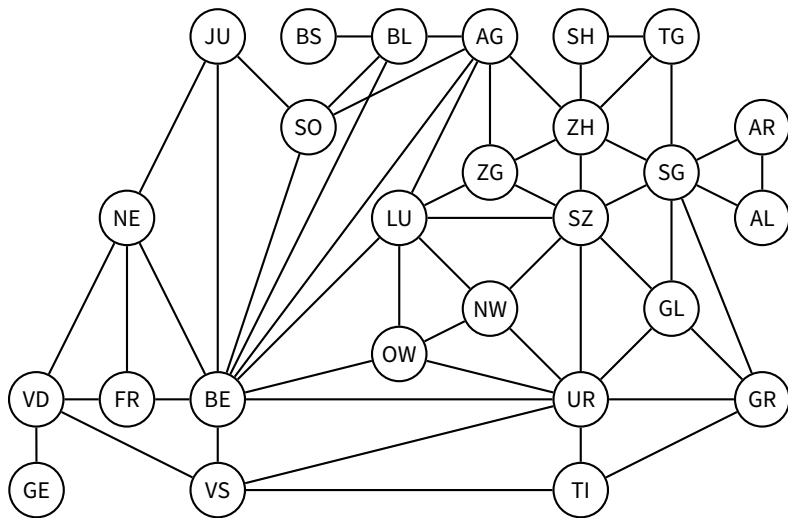

# Many Models and Applications

- Social networks: *who knows who*
- The Web graph: *which page links to which*
- The Internet graph: *which router links to which*
- Citation graphs: *who references whose papers*
- Planar graphs: *which country is next to which*
- Well-shaped meshes: *pretty pictures with triangles*
- Geometric graphs: *who is near who*
- Random graphs: *whichever...*

Examples and descriptions taken from Daniel A. Spielman's course "Graphs and Networks."

# Example (1)

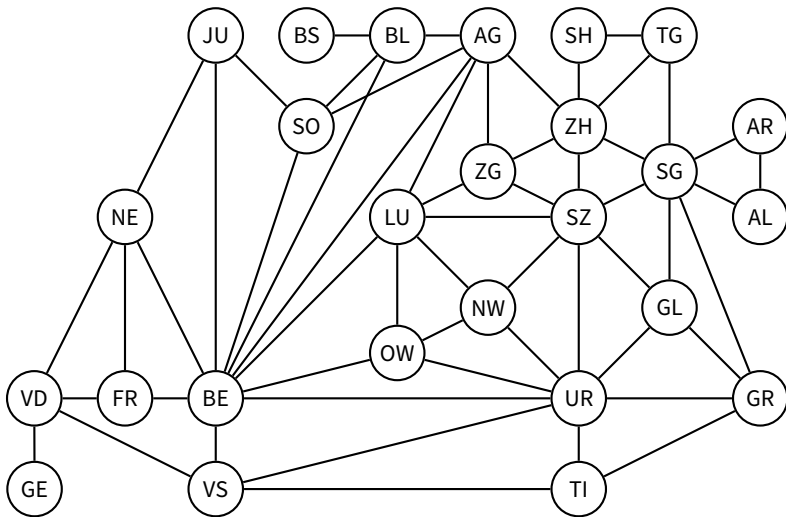

## Example (2)

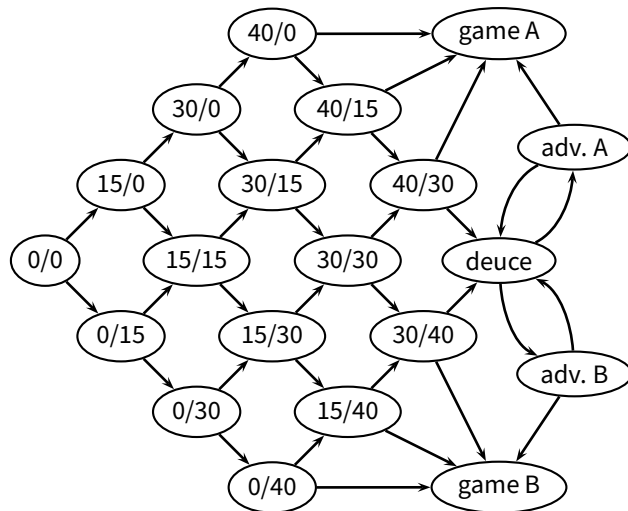

## Example (3)

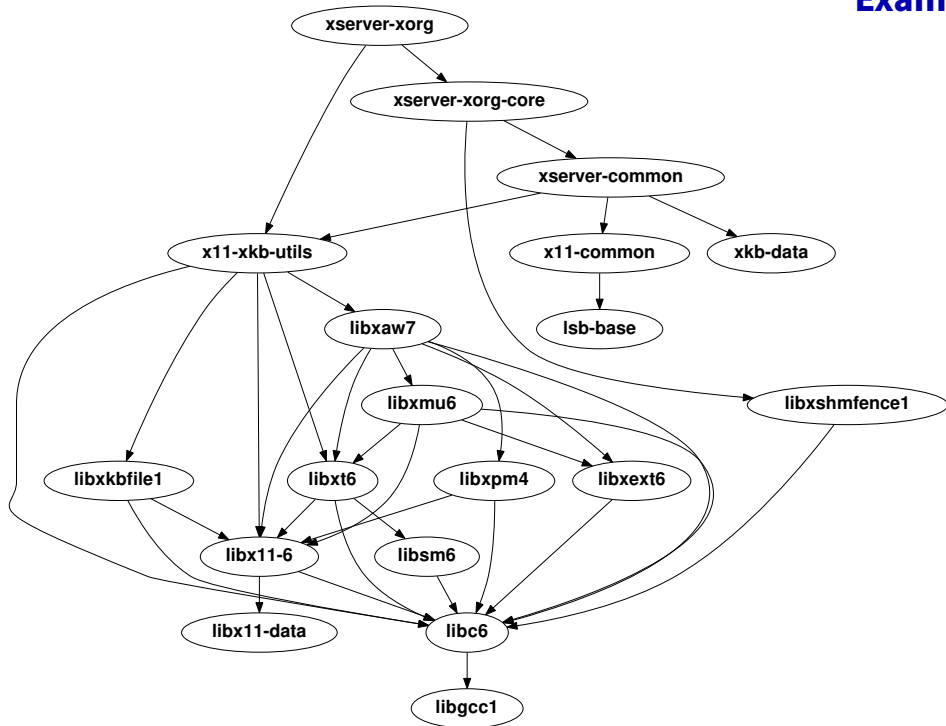

- A *graph*

$$G = (V, E)$$

- $V$  is the set of *vertices* (also called *nodes*)
- $E$  is the set of *edges*

- A **graph**

$$G = (V, E)$$

- $V$  is the set of **vertices** (also called **nodes**)

- $E$  is the set of **edges**

- ▶  $E \subseteq V \times V$ , i.e.,  $E$  is a **relation between vertices**

- ▶ an edge  $e = (u, v) \in E$  is a pair of vertices  $u \in V$  and  $v \in V$

- A **graph**

$$G = (V, E)$$

- $V$  is the set of **vertices** (also called **nodes**)

- $E$  is the set of **edges**

- ▶  $E \subseteq V \times V$ , i.e.,  $E$  is a **relation between vertices**

- ▶ an edge  $e = (u, v) \in E$  is a pair of vertices  $u \in V$  and  $v \in V$

- An **undirected** graph is characterized by a **symmetric** relation between vertices

- ▶ an edge is a set  $e = \{u, v\}$  of two vertices

- How do we represent a graph  $G = (E, V)$  in a computer?

- How do we represent a graph  $G = (E, V)$  in a computer?
- *Adjacency-list representation*
- $V = \{1, 2, \dots, |V|\}$
- $G$  consists of an array  $Adj$
- A vertex  $u \in V$  is represented by an element in the array  $Adj$

- How do we represent a graph  $G = (E, V)$  in a computer?
- *Adjacency-list representation*
- $V = \{1, 2, \dots, |V|\}$
- $G$  consists of an array  $Adj$
- A vertex  $u \in V$  is represented by an element in the array  $Adj$
- $Adj[u]$  is the **adjacency list** of vertex  $u$ 
  - ▶ the list of the vertices that are adjacent to  $u$
  - ▶ i.e., the list of all  $v$  such that  $(u, v) \in E$

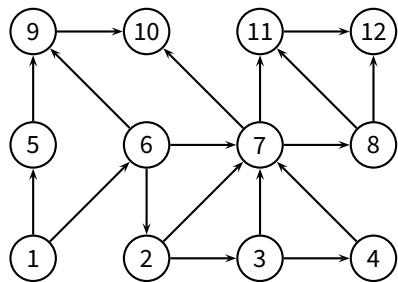

# Example

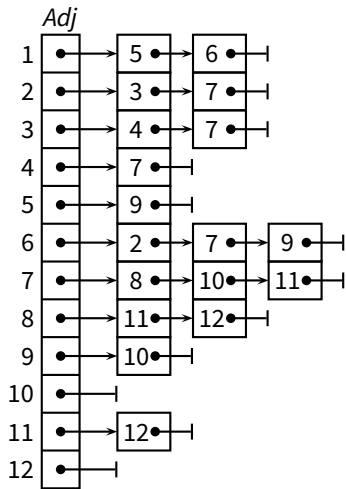
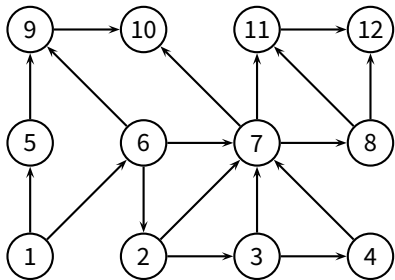

# Using the Adjacency List

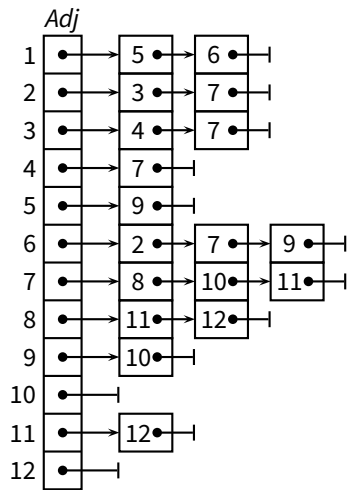

# Using the Adjacency List

- Accessing a vertex  $u$ ?

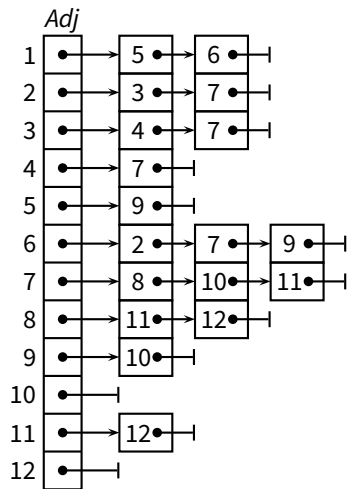

# Using the Adjacency List

■ Accessing a vertex  $u$ ?

- ▶ optimal

$O(1)$

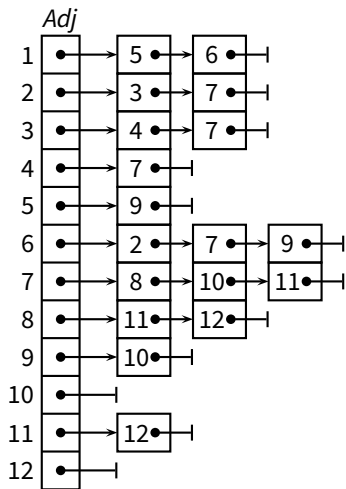

# Using the Adjacency List

- Accessing a vertex  $u$ ?
  - ▶ optimal
- Iteration through  $V$ ?

$O(1)$

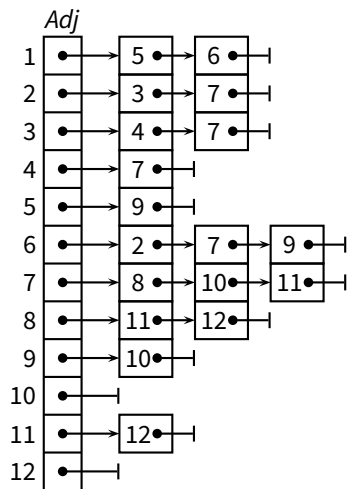

# Using the Adjacency List

■ Accessing a vertex  $u$ ?

▶ optimal

■ Iteration through  $V$ ?

▶ optimal

$O(1)$

$\Theta(|V|)$

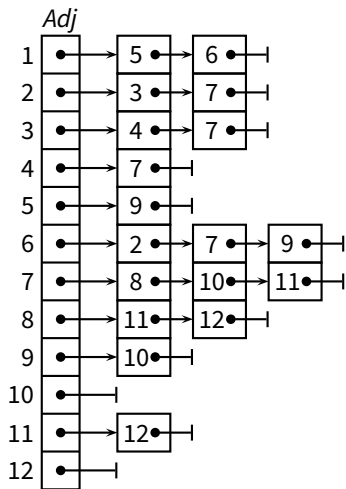

# Using the Adjacency List

- Accessing a vertex  $u$ ?
  - ▶ optimal
- Iteration through  $V$ ?
  - ▶ optimal
- Iteration through  $E$ ?

$O(1)$

$\Theta(|V|)$

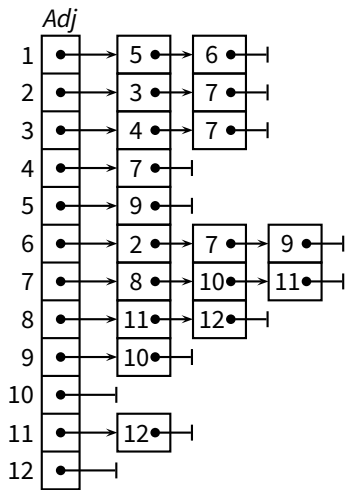

# Using the Adjacency List

■ Accessing a vertex  $u$ ?

▶ optimal

■ Iteration through  $V$ ?

▶ optimal

■ Iteration through  $E$ ?

▶ okay (not optimal)

$O(1)$

$\Theta(|V|)$

$\Theta(|V| + |E|)$

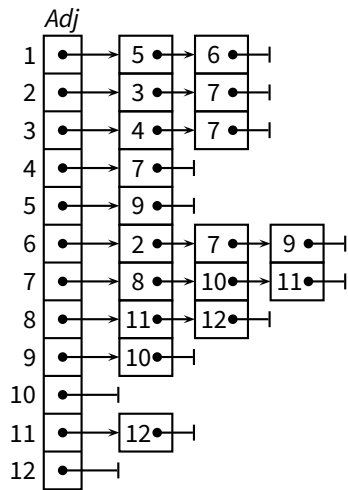

# Using the Adjacency List

- Accessing a vertex  $u$ ?

- ▶ optimal

- Iteration through  $V$ ?

- ▶ optimal

- Iteration through  $E$ ?

- ▶ okay (not optimal)

- Checking  $(u, v) \in E$ ?

$O(1)$

$\Theta(|V|)$

$\Theta(|V| + |E|)$

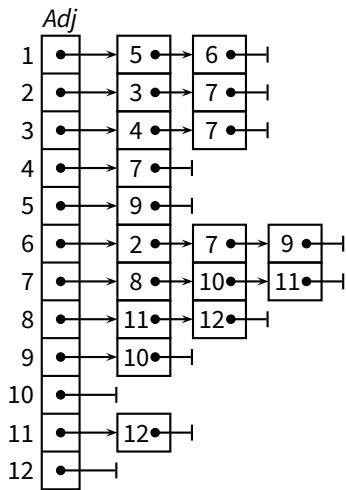

# Using the Adjacency List

■ Accessing a vertex  $u$ ?

▶ optimal

■ Iteration through  $V$ ?

▶ optimal

■ Iteration through  $E$ ?

▶ okay (not optimal)

■ Checking  $(u, v) \in E$ ?

$O(1)$

$\Theta(|V|)$

$\Theta(|V| + |E|)$

$O(|V|)$

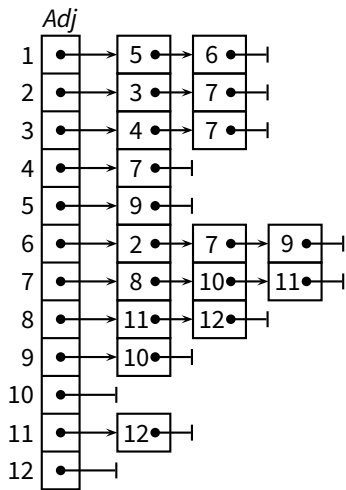

# Using the Adjacency List

■ Accessing a vertex  $u$ ?

▶ optimal

■ Iteration through  $V$ ?

▶ optimal

■ Iteration through  $E$ ?

▶ okay (not optimal)

■ Checking  $(u, v) \in E$ ?

▶ bad

$O(1)$

$\Theta(|V|)$

$\Theta(|V| + |E|)$

$O(|V|)$

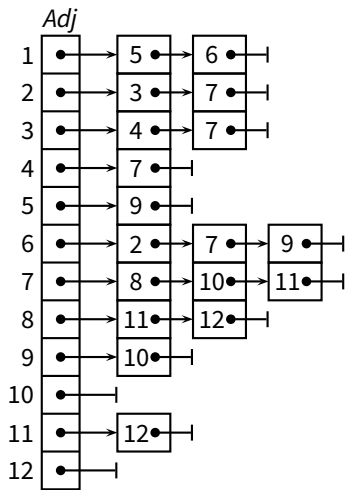

## Graph Representation (2)

- *Adjacency-matrix representation*

- $V = \{1, 2, \dots, |V|\}$

- $G$  consists of a  $|V| \times |V|$  matrix  $A$

- $A = (a_{ij})$  such that

$$a_{ij} = \begin{cases} 1 & \text{if } (i,j) \in E \\ 0 & \text{otherwise} \end{cases}$$

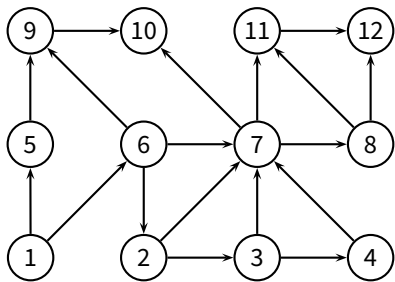



























- Adjacency-list representation

- Adjacency-list representation

$$\Theta(|V| + |E|)$$

- Adjacency-list representation

$$\Theta(|V| + |E|)$$

optimal

- Adjacency-list representation

$$\Theta(|V| + |E|)$$

optimal

- Adjacency-matrix representation

- Adjacency-list representation

$$\Theta(|V| + |E|)$$

optimal

- Adjacency-matrix representation

$$\Theta(|V|^2)$$

- Adjacency-list representation

$$\Theta(|V| + |E|)$$

optimal

- Adjacency-matrix representation

$$\Theta(|V|^2)$$

possibly very bad

- Adjacency-list representation

$$\Theta(|V| + |E|)$$

optimal

- Adjacency-matrix representation

$$\Theta(|V|^2)$$

possibly very bad

- When is the adjacency-matrix “very bad”?

# Choosing a Graph Representation

## ■ Adjacency-list representation

- ▶ generally good, especially for its optimal space complexity
- ▶ bad for **dense** graphs and algorithms that require random access to edges
- ▶ preferable for **sparse** graphs or graphs with **low degree**

# Choosing a Graph Representation

## ■ Adjacency-list representation

- ▶ generally good, especially for its optimal space complexity
- ▶ bad for **dense** graphs and algorithms that require random access to edges
- ▶ preferable for **sparse** graphs or graphs with **low degree**

## ■ Adjacency-matrix representation

- ▶ suffers from a bad space complexity
- ▶ good for algorithms that require random access to edges
- ▶ preferable for **dense** graphs

- One of the simplest but also a fundamental algorithm

- One of the simplest but also a fundamental algorithm
- *Input:*  $G = (V, E)$  and a vertex  $s \in V$ 
  - ▶ explores the graph, touching all vertices that are reachable from  $s$
  - ▶ iterates through the vertices at increasing distance (edge distance)
  - ▶ computes the distance of each vertex from  $s$
  - ▶ produces a ***breadth-first tree*** rooted at  $s$
  - ▶ works on both *directed* and *undirected* graphs

# Example

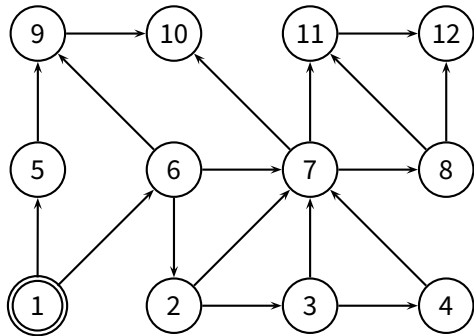

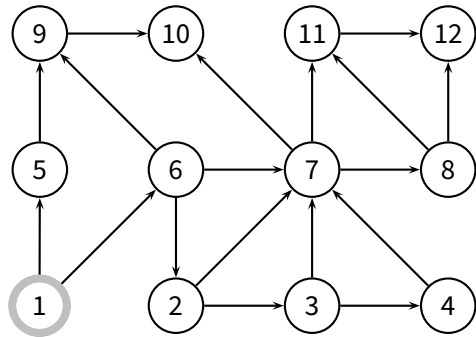

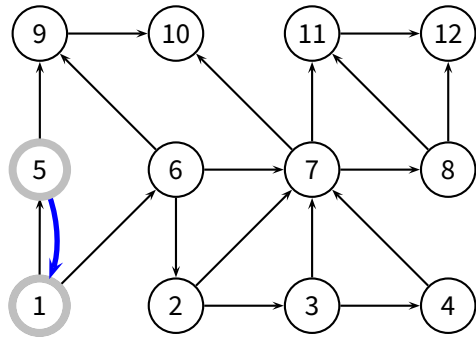

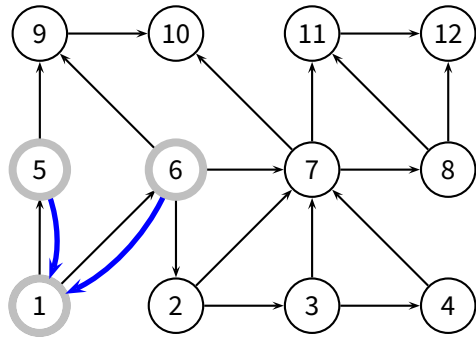

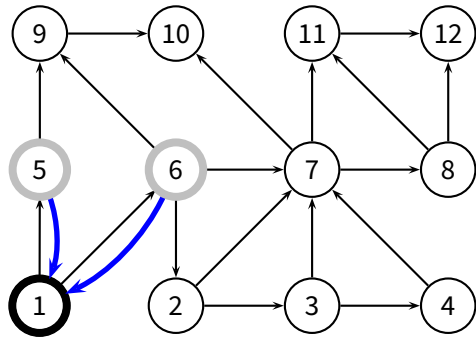

# Example

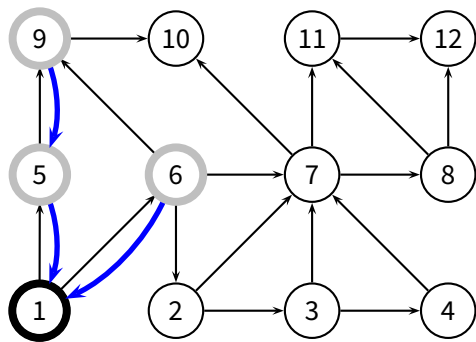

# Example

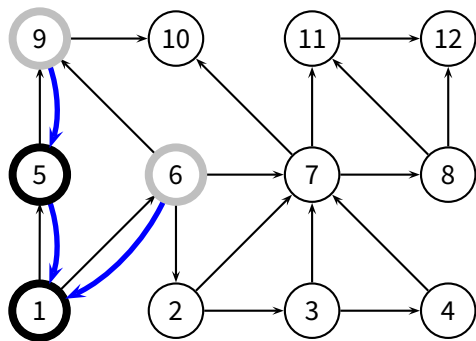

# Example

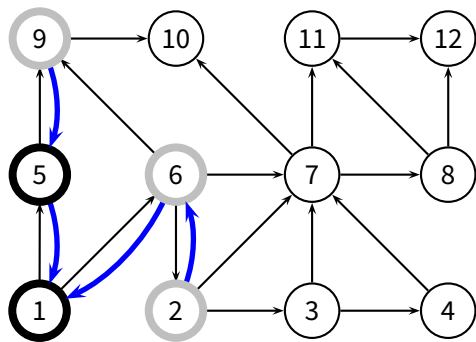

# Example

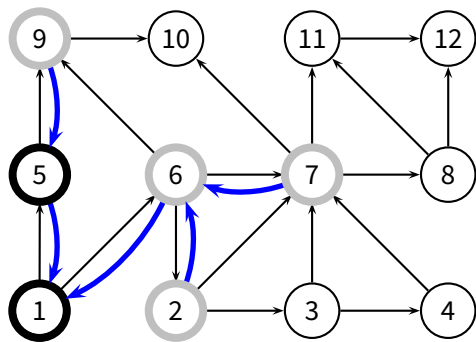

# Example

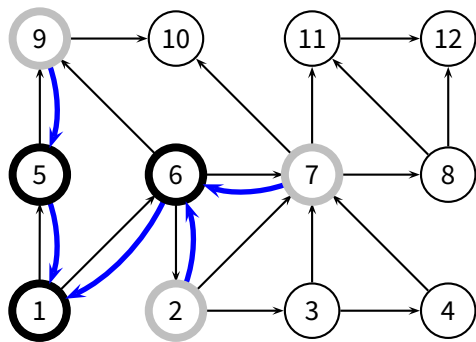

# Example

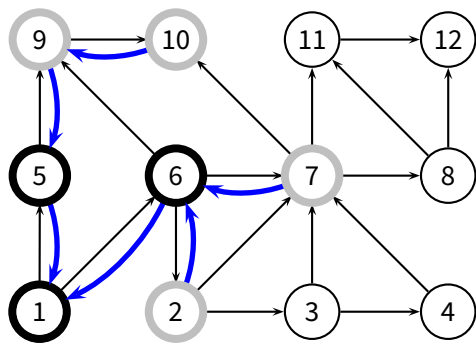

# Example

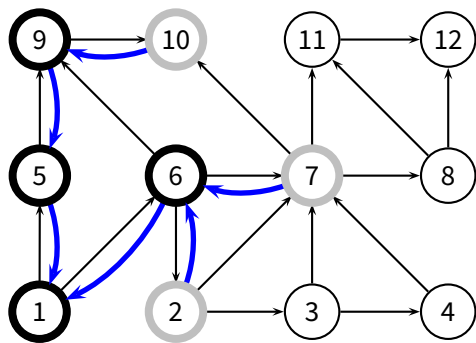

# Example

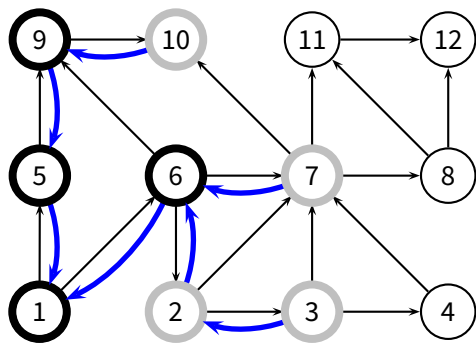

# Example

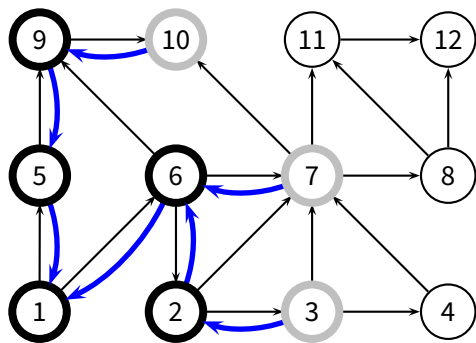

# Example

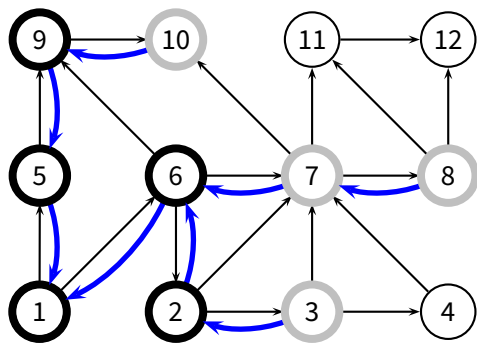

# Example

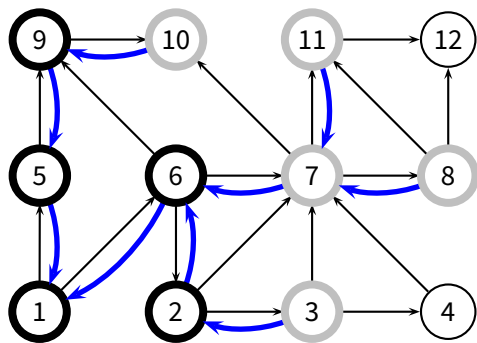

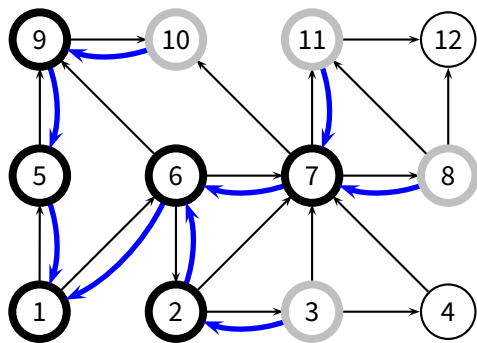

# Example

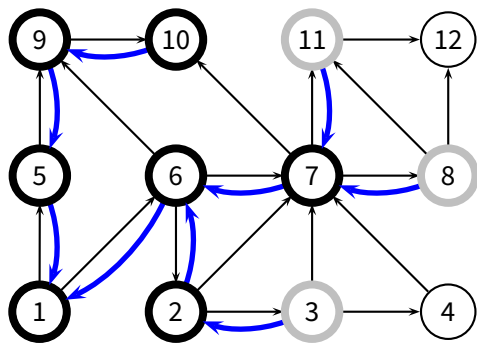

# Example

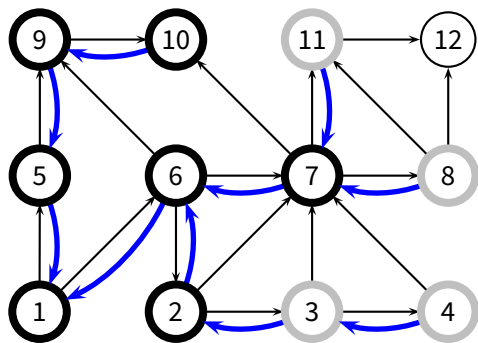

# Example

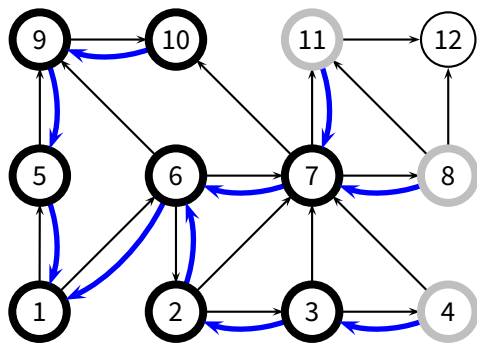

# Example

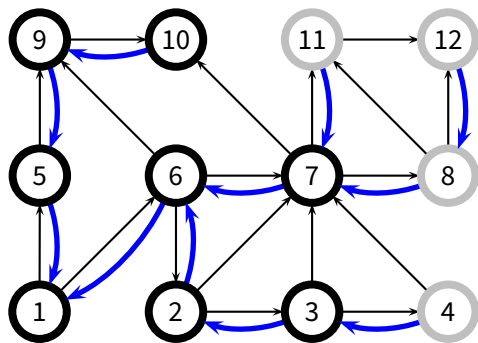

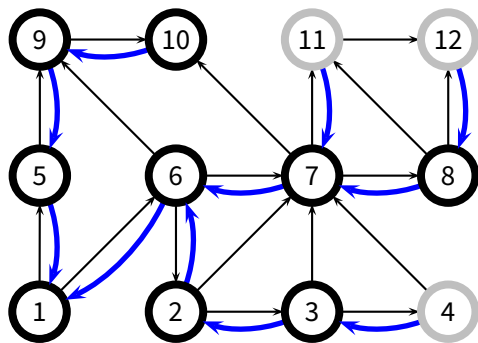

# Example

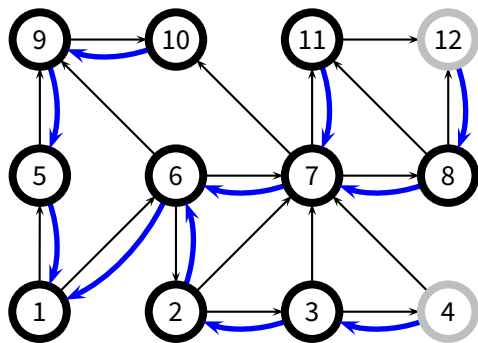

# Example

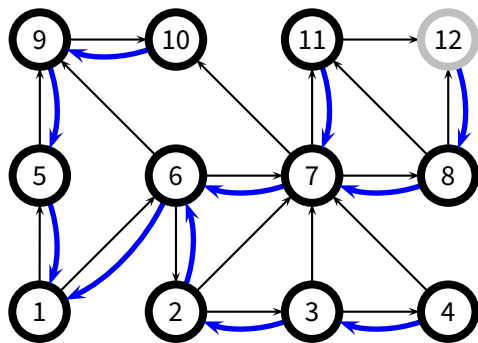

# Example

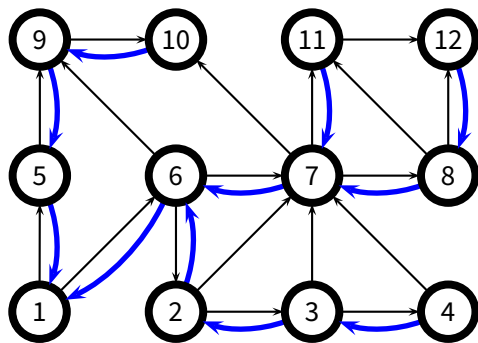

# BFS Algorithm

**BFS**( $G, s$ )

```
1  for each vertex  $u \in V(G) \setminus \{s\}$ 
2       $color[u] = \text{WHITE}$ 
3       $d[u] = \infty$ 
4       $\pi[u] = \text{NIL}$ 
5   $color[s] = \text{GRAY}$ 
6   $d[s] = 0$ 
7   $\pi[s] = \text{NIL}$ 
8   $Q = \emptyset$ 
9  ENQUEUE( $Q, s$ )
10 while  $Q \neq \emptyset$ 
11      $u = \text{DEQUEUE}(Q)$ 
12     for each  $v \in \text{Adj}[u]$ 
13         if  $color[v] == \text{WHITE}$ 
14              $color[v] = \text{GRAY}$ 
15              $d[v] = d[u] + 1$ 
16              $\pi[v] = u$ 
17             ENQUEUE( $Q, v$ )
18      $color[u] = \text{BLACK}$ 
```

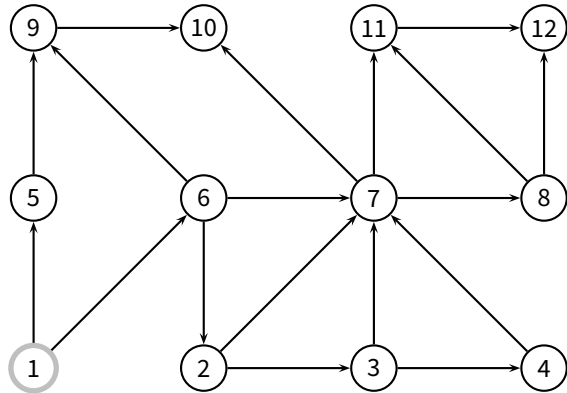

# BFS Algorithm

**BFS**( $G, s$ )

```
1  for each vertex  $u \in V(G) \setminus \{s\}$ 
2       $color[u] = \text{WHITE}$ 
3       $d[u] = \infty$ 
4       $\pi[u] = \text{NIL}$ 
5   $color[s] = \text{GRAY}$ 
6   $d[s] = 0$ 
7   $\pi[s] = \text{NIL}$ 
8   $Q = \emptyset$ 
9  ENQUEUE( $Q, s$ )
10 while  $Q \neq \emptyset$ 
11      $u = \text{DEQUEUE}(Q)$ 
12     for each  $v \in \text{Adj}[u]$ 
13         if  $color[v] == \text{WHITE}$ 
14              $color[v] = \text{GRAY}$ 
15              $d[v] = d[u] + 1$ 
16              $\pi[v] = u$ 
17             ENQUEUE( $Q, v$ )
18      $color[u] = \text{BLACK}$ 
```

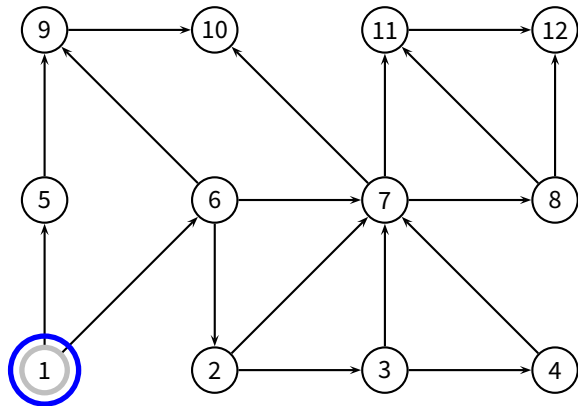

$u = 1$

$Q = \emptyset$

# BFS Algorithm

**BFS**( $G, s$ )

```
1  for each vertex  $u \in V(G) \setminus \{s\}$ 
2       $color[u] = \text{WHITE}$ 
3       $d[u] = \infty$ 
4       $\pi[u] = \text{NIL}$ 
5   $color[s] = \text{GRAY}$ 
6   $d[s] = 0$ 
7   $\pi[s] = \text{NIL}$ 
8   $Q = \emptyset$ 
9  ENQUEUE( $Q, s$ )
10 while  $Q \neq \emptyset$ 
11      $u = \text{DEQUEUE}(Q)$ 
12     for each  $v \in \text{Adj}[u]$ 
13         if  $color[v] == \text{WHITE}$ 
14              $color[v] = \text{GRAY}$ 
15              $d[v] = d[u] + 1$ 
16              $\pi[v] = u$ 
17             ENQUEUE( $Q, v$ )
18      $color[u] = \text{BLACK}$ 
```

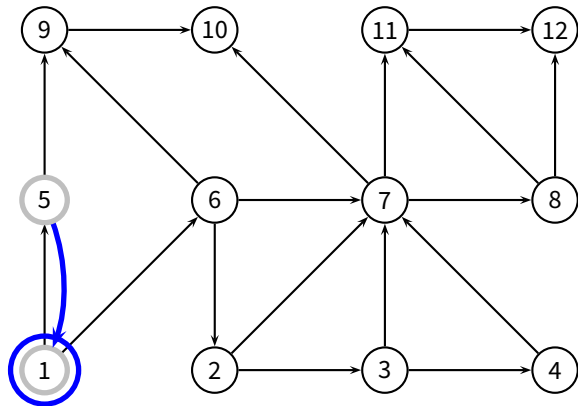

$u = 1$

$Q = \{5\}$

# BFS Algorithm

**BFS**( $G, s$ )

```
1  for each vertex  $u \in V(G) \setminus \{s\}$ 
2       $color[u] = \text{WHITE}$ 
3       $d[u] = \infty$ 
4       $\pi[u] = \text{NIL}$ 
5   $color[s] = \text{GRAY}$ 
6   $d[s] = 0$ 
7   $\pi[s] = \text{NIL}$ 
8   $Q = \emptyset$ 
9  ENQUEUE( $Q, s$ )
10 while  $Q \neq \emptyset$ 
11      $u = \text{DEQUEUE}(Q)$ 
12     for each  $v \in \text{Adj}[u]$ 
13         if  $color[v] == \text{WHITE}$ 
14              $color[v] = \text{GRAY}$ 
15              $d[v] = d[u] + 1$ 
16              $\pi[v] = u$ 
17             ENQUEUE( $Q, v$ )
18      $color[u] = \text{BLACK}$ 
```

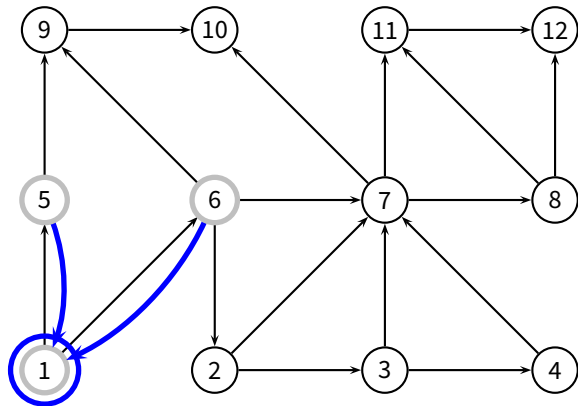

$u = 1$

$Q = \{5, 6\}$

# BFS Algorithm

**BFS**( $G, s$ )

```
1  for each vertex  $u \in V(G) \setminus \{s\}$ 
2       $color[u] = \text{WHITE}$ 
3       $d[u] = \infty$ 
4       $\pi[u] = \text{NIL}$ 
5   $color[s] = \text{GRAY}$ 
6   $d[s] = 0$ 
7   $\pi[s] = \text{NIL}$ 
8   $Q = \emptyset$ 
9  ENQUEUE( $Q, s$ )
10 while  $Q \neq \emptyset$ 
11      $u = \text{DEQUEUE}(Q)$ 
12     for each  $v \in \text{Adj}[u]$ 
13         if  $color[v] == \text{WHITE}$ 
14              $color[v] = \text{GRAY}$ 
15              $d[v] = d[u] + 1$ 
16              $\pi[v] = u$ 
17             ENQUEUE( $Q, v$ )
18      $color[u] = \text{BLACK}$ 
```

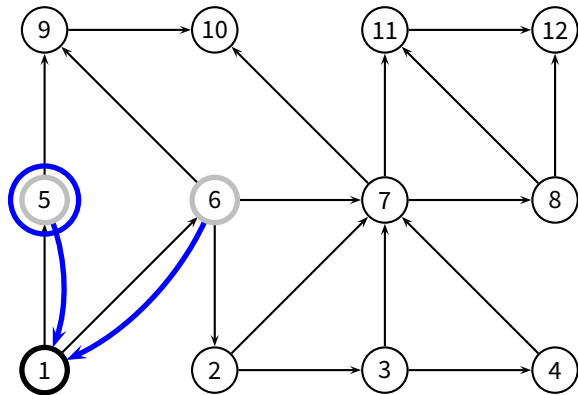

$u = 5$

$Q = \{6\}$

# BFS Algorithm

**BFS**( $G, s$ )

```
1  for each vertex  $u \in V(G) \setminus \{s\}$ 
2       $color[u] = \text{WHITE}$ 
3       $d[u] = \infty$ 
4       $\pi[u] = \text{NIL}$ 
5   $color[s] = \text{GRAY}$ 
6   $d[s] = 0$ 
7   $\pi[s] = \text{NIL}$ 
8   $Q = \emptyset$ 
9  ENQUEUE( $Q, s$ )
10 while  $Q \neq \emptyset$ 
11      $u = \text{DEQUEUE}(Q)$ 
12     for each  $v \in \text{Adj}[u]$ 
13         if  $color[v] == \text{WHITE}$ 
14              $color[v] = \text{GRAY}$ 
15              $d[v] = d[u] + 1$ 
16              $\pi[v] = u$ 
17             ENQUEUE( $Q, v$ )
18      $color[u] = \text{BLACK}$ 
```

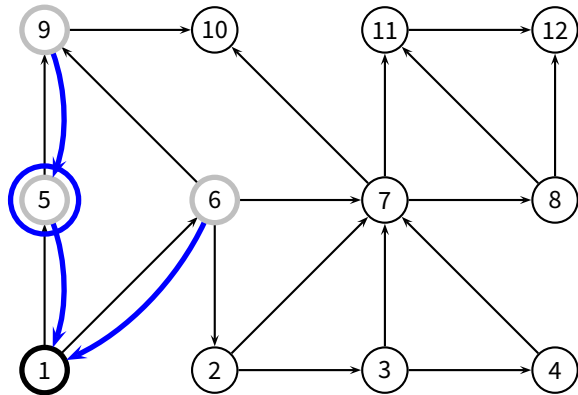

$u = 5$

$Q = \{6, 9\}$

# BFS Algorithm

**BFS**( $G, s$ )

```
1  for each vertex  $u \in V(G) \setminus \{s\}$ 
2       $color[u] = \text{WHITE}$ 
3       $d[u] = \infty$ 
4       $\pi[u] = \text{NIL}$ 
5   $color[s] = \text{GRAY}$ 
6   $d[s] = 0$ 
7   $\pi[s] = \text{NIL}$ 
8   $Q = \emptyset$ 
9  ENQUEUE( $Q, s$ )
10 while  $Q \neq \emptyset$ 
11      $u = \text{DEQUEUE}(Q)$ 
12     for each  $v \in \text{Adj}[u]$ 
13         if  $color[v] == \text{WHITE}$ 
14              $color[v] = \text{GRAY}$ 
15              $d[v] = d[u] + 1$ 
16              $\pi[v] = u$ 
17             ENQUEUE( $Q, v$ )
18      $color[u] = \text{BLACK}$ 
```

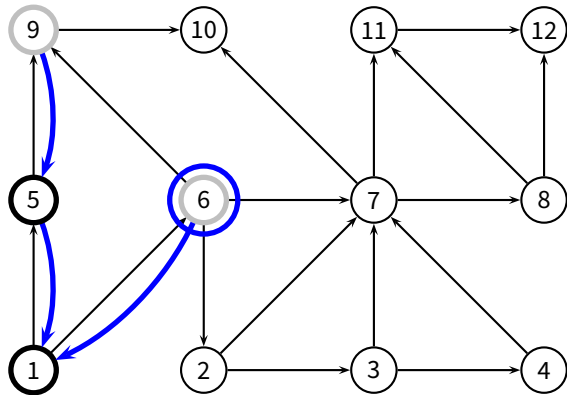

$u = 6$

$Q = \{9\}$

# BFS Algorithm

**BFS**( $G, s$ )

```
1  for each vertex  $u \in V(G) \setminus \{s\}$ 
2       $color[u] = \text{WHITE}$ 
3       $d[u] = \infty$ 
4       $\pi[u] = \text{NIL}$ 
5   $color[s] = \text{GRAY}$ 
6   $d[s] = 0$ 
7   $\pi[s] = \text{NIL}$ 
8   $Q = \emptyset$ 
9  ENQUEUE( $Q, s$ )
10 while  $Q \neq \emptyset$ 
11      $u = \text{DEQUEUE}(Q)$ 
12     for each  $v \in \text{Adj}[u]$ 
13         if  $color[v] == \text{WHITE}$ 
14              $color[v] = \text{GRAY}$ 
15              $d[v] = d[u] + 1$ 
16              $\pi[v] = u$ 
17             ENQUEUE( $Q, v$ )
18      $color[u] = \text{BLACK}$ 
```

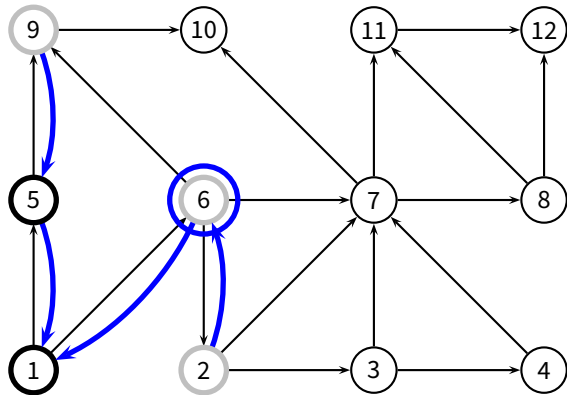

$u = 6$

$Q = \{9, 2, 7\}$

# BFS Algorithm

**BFS**( $G, s$ )

```
1  for each vertex  $u \in V(G) \setminus \{s\}$ 
2       $color[u] = \text{WHITE}$ 
3       $d[u] = \infty$ 
4       $\pi[u] = \text{NIL}$ 
5   $color[s] = \text{GRAY}$ 
6   $d[s] = 0$ 
7   $\pi[s] = \text{NIL}$ 
8   $Q = \emptyset$ 
9  ENQUEUE( $Q, s$ )
10 while  $Q \neq \emptyset$ 
11      $u = \text{DEQUEUE}(Q)$ 
12     for each  $v \in \text{Adj}[u]$ 
13         if  $color[v] == \text{WHITE}$ 
14              $color[v] = \text{GRAY}$ 
15              $d[v] = d[u] + 1$ 
16              $\pi[v] = u$ 
17             ENQUEUE( $Q, v$ )
18      $color[u] = \text{BLACK}$ 
```

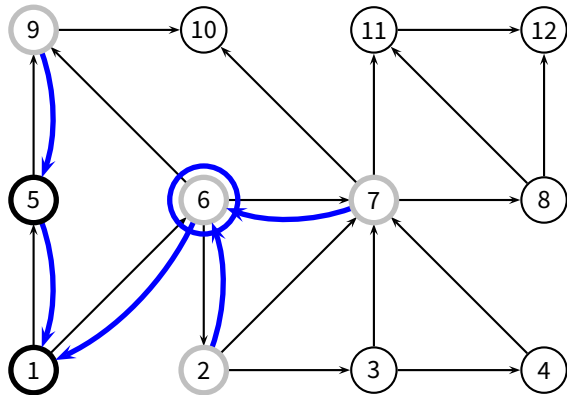

$u = 6$

$Q = \{9, 2, 7\}$

# BFS Algorithm

**BFS**( $G, s$ )

```
1  for each vertex  $u \in V(G) \setminus \{s\}$ 
2       $color[u] = \text{WHITE}$ 
3       $d[u] = \infty$ 
4       $\pi[u] = \text{NIL}$ 
5   $color[s] = \text{GRAY}$ 
6   $d[s] = 0$ 
7   $\pi[s] = \text{NIL}$ 
8   $Q = \emptyset$ 
9  ENQUEUE( $Q, s$ )
10 while  $Q \neq \emptyset$ 
11      $u = \text{DEQUEUE}(Q)$ 
12     for each  $v \in \text{Adj}[u]$ 
13         if  $color[v] == \text{WHITE}$ 
14              $color[v] = \text{GRAY}$ 
15              $d[v] = d[u] + 1$ 
16              $\pi[v] = u$ 
17             ENQUEUE( $Q, v$ )
18      $color[u] = \text{BLACK}$ 
```

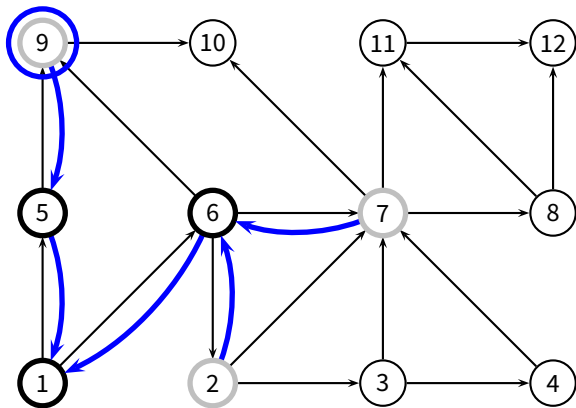

$u = 9$

$Q = \{2, 7\}$

# BFS Algorithm

**BFS**( $G, s$ )

```
1  for each vertex  $u \in V(G) \setminus \{s\}$ 
2       $color[u] = \text{WHITE}$ 
3       $d[u] = \infty$ 
4       $\pi[u] = \text{NIL}$ 
5   $color[s] = \text{GRAY}$ 
6   $d[s] = 0$ 
7   $\pi[s] = \text{NIL}$ 
8   $Q = \emptyset$ 
9  ENQUEUE( $Q, s$ )
10 while  $Q \neq \emptyset$ 
11      $u = \text{DEQUEUE}(Q)$ 
12     for each  $v \in \text{Adj}[u]$ 
13         if  $color[v] == \text{WHITE}$ 
14              $color[v] = \text{GRAY}$ 
15              $d[v] = d[u] + 1$ 
16              $\pi[v] = u$ 
17             ENQUEUE( $Q, v$ )
18      $color[u] = \text{BLACK}$ 
```

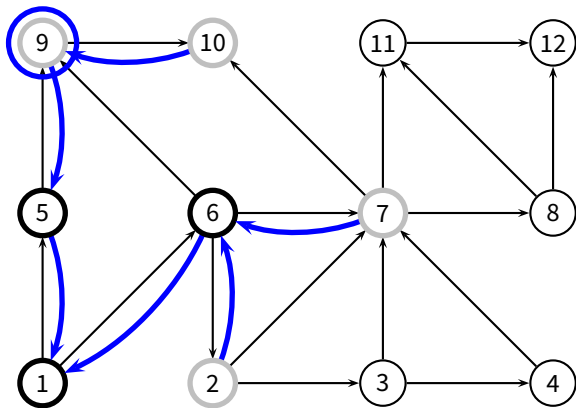

$u = 9$

$Q = \{2, 7, 10\}$

# BFS Algorithm

**BFS**( $G, s$ )

```
1  for each vertex  $u \in V(G) \setminus \{s\}$ 
2       $color[u] = \text{WHITE}$ 
3       $d[u] = \infty$ 
4       $\pi[u] = \text{NIL}$ 
5   $color[s] = \text{GRAY}$ 
6   $d[s] = 0$ 
7   $\pi[s] = \text{NIL}$ 
8   $Q = \emptyset$ 
9  ENQUEUE( $Q, s$ )
10 while  $Q \neq \emptyset$ 
11      $u = \text{DEQUEUE}(Q)$ 
12     for each  $v \in \text{Adj}[u]$ 
13         if  $color[v] == \text{WHITE}$ 
14              $color[v] = \text{GRAY}$ 
15              $d[v] = d[u] + 1$ 
16              $\pi[v] = u$ 
17             ENQUEUE( $Q, v$ )
18      $color[u] = \text{BLACK}$ 
```

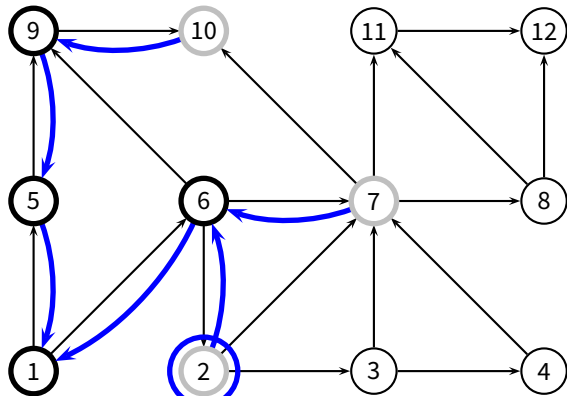

$u = 2$

$Q = \{7, 10\}$

# BFS Algorithm

**BFS**( $G, s$ )

```
1  for each vertex  $u \in V(G) \setminus \{s\}$ 
2       $color[u] = \text{WHITE}$ 
3       $d[u] = \infty$ 
4       $\pi[u] = \text{NIL}$ 
5   $color[s] = \text{GRAY}$ 
6   $d[s] = 0$ 
7   $\pi[s] = \text{NIL}$ 
8   $Q = \emptyset$ 
9  ENQUEUE( $Q, s$ )
10 while  $Q \neq \emptyset$ 
11      $u = \text{DEQUEUE}(Q)$ 
12     for each  $v \in \text{Adj}[u]$ 
13         if  $color[v] == \text{WHITE}$ 
14              $color[v] = \text{GRAY}$ 
15              $d[v] = d[u] + 1$ 
16              $\pi[v] = u$ 
17             ENQUEUE( $Q, v$ )
18      $color[u] = \text{BLACK}$ 
```

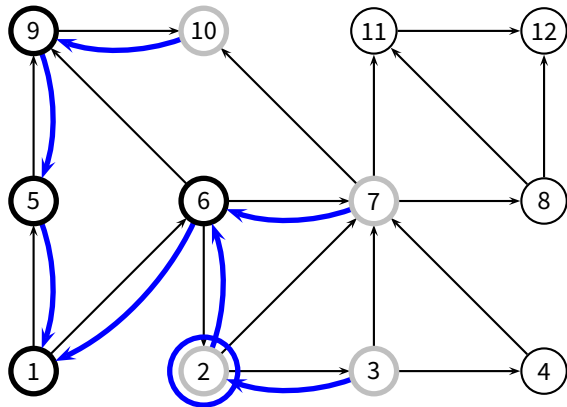

$u = 2$

$Q = \{7, 10, 3\}$

# BFS Algorithm

**BFS**( $G, s$ )

```
1  for each vertex  $u \in V(G) \setminus \{s\}$ 
2       $color[u] = \text{WHITE}$ 
3       $d[u] = \infty$ 
4       $\pi[u] = \text{NIL}$ 
5   $color[s] = \text{GRAY}$ 
6   $d[s] = 0$ 
7   $\pi[s] = \text{NIL}$ 
8   $Q = \emptyset$ 
9  ENQUEUE( $Q, s$ )
10 while  $Q \neq \emptyset$ 
11      $u = \text{DEQUEUE}(Q)$ 
12     for each  $v \in \text{Adj}[u]$ 
13         if  $color[v] == \text{WHITE}$ 
14              $color[v] = \text{GRAY}$ 
15              $d[v] = d[u] + 1$ 
16              $\pi[v] = u$ 
17             ENQUEUE( $Q, v$ )
18      $color[u] = \text{BLACK}$ 
```

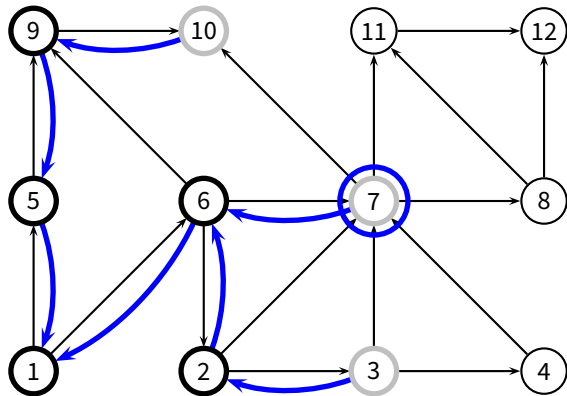

$u = 7$

$Q = \{10, 3\}$

# BFS Algorithm

**BFS**( $G, s$ )

```
1  for each vertex  $u \in V(G) \setminus \{s\}$ 
2       $color[u] = \text{WHITE}$ 
3       $d[u] = \infty$ 
4       $\pi[u] = \text{NIL}$ 
5   $color[s] = \text{GRAY}$ 
6   $d[s] = 0$ 
7   $\pi[s] = \text{NIL}$ 
8   $Q = \emptyset$ 
9  ENQUEUE( $Q, s$ )
10 while  $Q \neq \emptyset$ 
11      $u = \text{DEQUEUE}(Q)$ 
12     for each  $v \in \text{Adj}[u]$ 
13         if  $color[v] == \text{WHITE}$ 
14              $color[v] = \text{GRAY}$ 
15              $d[v] = d[u] + 1$ 
16              $\pi[v] = u$ 
17             ENQUEUE( $Q, v$ )
18      $color[u] = \text{BLACK}$ 
```

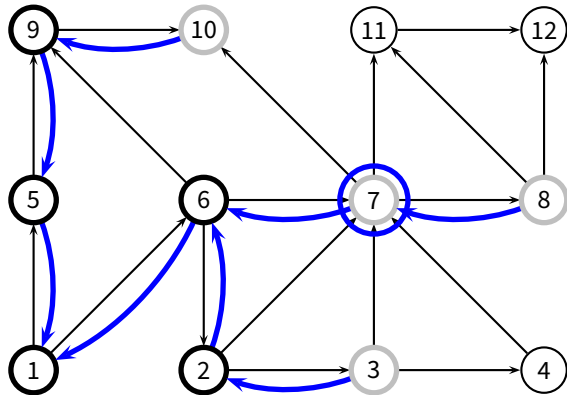

$u = 7$

$Q = \{10, 3, 8\}$

# BFS Algorithm

**BFS**( $G, s$ )

```
1  for each vertex  $u \in V(G) \setminus \{s\}$ 
2       $color[u] = \text{WHITE}$ 
3       $d[u] = \infty$ 
4       $\pi[u] = \text{NIL}$ 
5   $color[s] = \text{GRAY}$ 
6   $d[s] = 0$ 
7   $\pi[s] = \text{NIL}$ 
8   $Q = \emptyset$ 
9  ENQUEUE( $Q, s$ )
10 while  $Q \neq \emptyset$ 
11      $u = \text{DEQUEUE}(Q)$ 
12     for each  $v \in \text{Adj}[u]$ 
13         if  $color[v] == \text{WHITE}$ 
14              $color[v] = \text{GRAY}$ 
15              $d[v] = d[u] + 1$ 
16              $\pi[v] = u$ 
17             ENQUEUE( $Q, v$ )
18      $color[u] = \text{BLACK}$ 
```

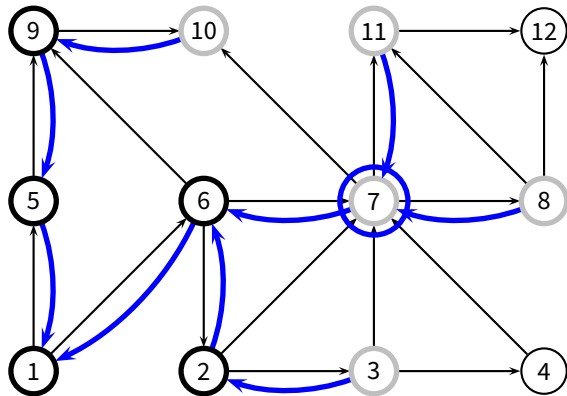

$u = 7$

$Q = \{10, 3, 8, 11\}$

# BFS Algorithm

**BFS**( $G, s$ )

```
1  for each vertex  $u \in V(G) \setminus \{s\}$ 
2       $color[u] = \text{WHITE}$ 
3       $d[u] = \infty$ 
4       $\pi[u] = \text{NIL}$ 
5   $color[s] = \text{GRAY}$ 
6   $d[s] = 0$ 
7   $\pi[s] = \text{NIL}$ 
8   $Q = \emptyset$ 
9  ENQUEUE( $Q, s$ )
10 while  $Q \neq \emptyset$ 
11      $u = \text{DEQUEUE}(Q)$ 
12     for each  $v \in \text{Adj}[u]$ 
13         if  $color[v] == \text{WHITE}$ 
14              $color[v] = \text{GRAY}$ 
15              $d[v] = d[u] + 1$ 
16              $\pi[v] = u$ 
17             ENQUEUE( $Q, v$ )
18      $color[u] = \text{BLACK}$ 
```

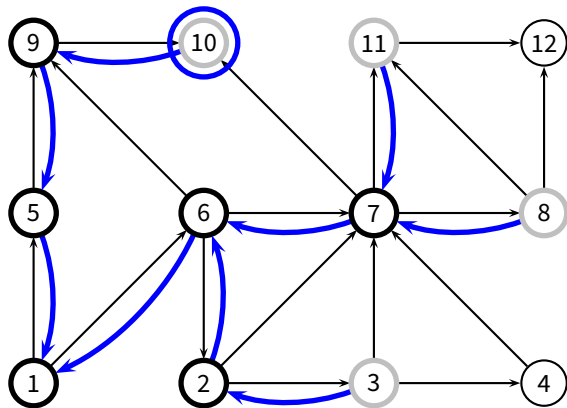

$u = 10$

$Q = \{3, 8, 11\}$

# BFS Algorithm

**BFS**( $G, s$ )

```
1  for each vertex  $u \in V(G) \setminus \{s\}$ 
2       $color[u] = \text{WHITE}$ 
3       $d[u] = \infty$ 
4       $\pi[u] = \text{NIL}$ 
5   $color[s] = \text{GRAY}$ 
6   $d[s] = 0$ 
7   $\pi[s] = \text{NIL}$ 
8   $Q = \emptyset$ 
9  ENQUEUE( $Q, s$ )
10 while  $Q \neq \emptyset$ 
11      $u = \text{DEQUEUE}(Q)$ 
12     for each  $v \in \text{Adj}[u]$ 
13         if  $color[v] == \text{WHITE}$ 
14              $color[v] = \text{GRAY}$ 
15              $d[v] = d[u] + 1$ 
16              $\pi[v] = u$ 
17             ENQUEUE( $Q, v$ )
18      $color[u] = \text{BLACK}$ 
```

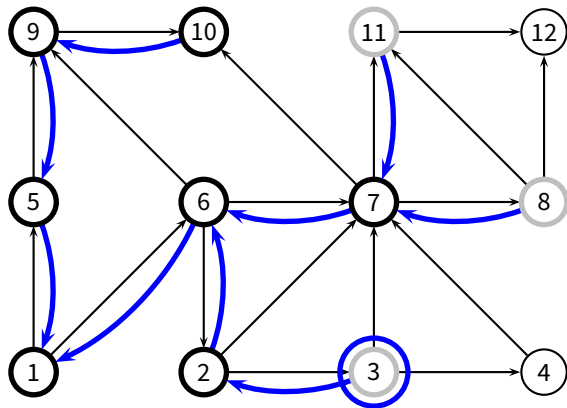

$u = 3$

$Q = \{8, 11\}$

# BFS Algorithm

**BFS**( $G, s$ )

```
1  for each vertex  $u \in V(G) \setminus \{s\}$ 
2       $color[u] = \text{WHITE}$ 
3       $d[u] = \infty$ 
4       $\pi[u] = \text{NIL}$ 
5   $color[s] = \text{GRAY}$ 
6   $d[s] = 0$ 
7   $\pi[s] = \text{NIL}$ 
8   $Q = \emptyset$ 
9  ENQUEUE( $Q, s$ )
10 while  $Q \neq \emptyset$ 
11      $u = \text{DEQUEUE}(Q)$ 
12     for each  $v \in \text{Adj}[u]$ 
13         if  $color[v] == \text{WHITE}$ 
14              $color[v] = \text{GRAY}$ 
15              $d[v] = d[u] + 1$ 
16              $\pi[v] = u$ 
17             ENQUEUE( $Q, v$ )
18      $color[u] = \text{BLACK}$ 
```

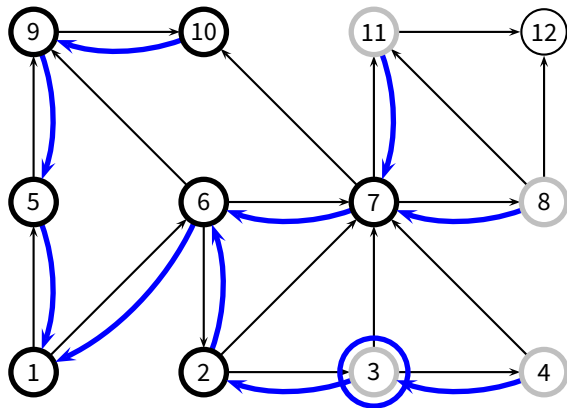

$u = 3$

$Q = \{8, 11, 4\}$

# BFS Algorithm

**BFS**( $G, s$ )

```
1  for each vertex  $u \in V(G) \setminus \{s\}$ 
2       $color[u] = \text{WHITE}$ 
3       $d[u] = \infty$ 
4       $\pi[u] = \text{NIL}$ 
5   $color[s] = \text{GRAY}$ 
6   $d[s] = 0$ 
7   $\pi[s] = \text{NIL}$ 
8   $Q = \emptyset$ 
9  ENQUEUE( $Q, s$ )
10 while  $Q \neq \emptyset$ 
11      $u = \text{DEQUEUE}(Q)$ 
12     for each  $v \in \text{Adj}[u]$ 
13         if  $color[v] == \text{WHITE}$ 
14              $color[v] = \text{GRAY}$ 
15              $d[v] = d[u] + 1$ 
16              $\pi[v] = u$ 
17             ENQUEUE( $Q, v$ )
18      $color[u] = \text{BLACK}$ 
```

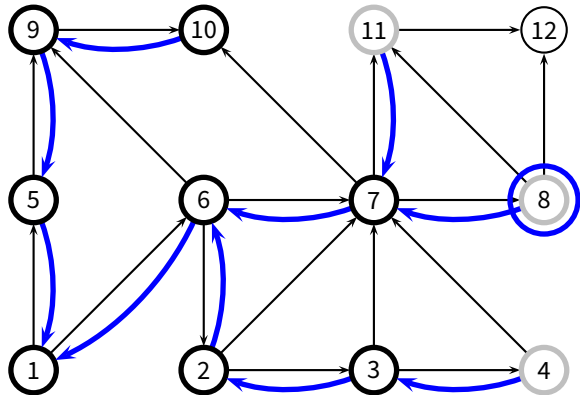

$u = 8$

$Q = \{11, 4\}$



# BFS Algorithm

**BFS**( $G, s$ )

```
1  for each vertex  $u \in V(G) \setminus \{s\}$ 
2       $color[u] = \text{WHITE}$ 
3       $d[u] = \infty$ 
4       $\pi[u] = \text{NIL}$ 
5   $color[s] = \text{GRAY}$ 
6   $d[s] = 0$ 
7   $\pi[s] = \text{NIL}$ 
8   $Q = \emptyset$ 
9  ENQUEUE( $Q, s$ )
10 while  $Q \neq \emptyset$ 
11      $u = \text{DEQUEUE}(Q)$ 
12     for each  $v \in \text{Adj}[u]$ 
13         if  $color[v] == \text{WHITE}$ 
14              $color[v] = \text{GRAY}$ 
15              $d[v] = d[u] + 1$ 
16              $\pi[v] = u$ 
17             ENQUEUE( $Q, v$ )
18      $color[u] = \text{BLACK}$ 
```

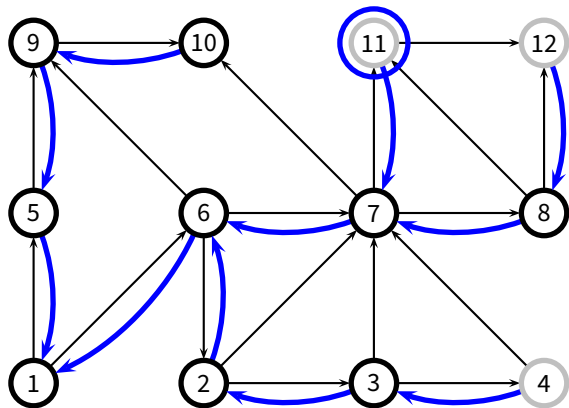

$u = 11$

$Q = \{4, 12\}$

# BFS Algorithm

**BFS**( $G, s$ )

```
1  for each vertex  $u \in V(G) \setminus \{s\}$ 
2       $color[u] = \text{WHITE}$ 
3       $d[u] = \infty$ 
4       $\pi[u] = \text{NIL}$ 
5   $color[s] = \text{GRAY}$ 
6   $d[s] = 0$ 
7   $\pi[s] = \text{NIL}$ 
8   $Q = \emptyset$ 
9  ENQUEUE( $Q, s$ )
10 while  $Q \neq \emptyset$ 
11      $u = \text{DEQUEUE}(Q)$ 
12     for each  $v \in \text{Adj}[u]$ 
13         if  $color[v] == \text{WHITE}$ 
14              $color[v] = \text{GRAY}$ 
15              $d[v] = d[u] + 1$ 
16              $\pi[v] = u$ 
17             ENQUEUE( $Q, v$ )
18      $color[u] = \text{BLACK}$ 
```

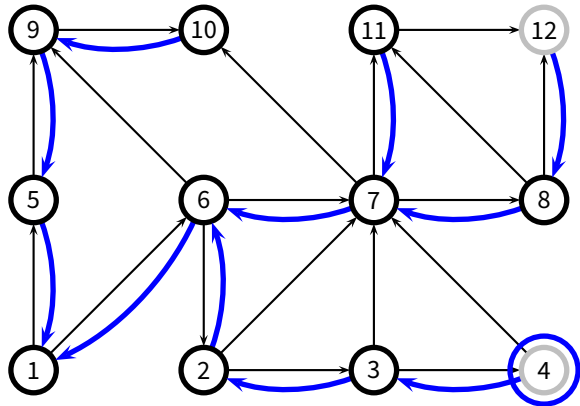

$u = 4$

$Q = \{12\}$

# BFS Algorithm

**BFS**( $G, s$ )

```
1  for each vertex  $u \in V(G) \setminus \{s\}$ 
2       $color[u] = \text{WHITE}$ 
3       $d[u] = \infty$ 
4       $\pi[u] = \text{NIL}$ 
5   $color[s] = \text{GRAY}$ 
6   $d[s] = 0$ 
7   $\pi[s] = \text{NIL}$ 
8   $Q = \emptyset$ 
9  ENQUEUE( $Q, s$ )
10 while  $Q \neq \emptyset$ 
11      $u = \text{DEQUEUE}(Q)$ 
12     for each  $v \in \text{Adj}[u]$ 
13         if  $color[v] == \text{WHITE}$ 
14              $color[v] = \text{GRAY}$ 
15              $d[v] = d[u] + 1$ 
16              $\pi[v] = u$ 
17             ENQUEUE( $Q, v$ )
18      $color[u] = \text{BLACK}$ 
```

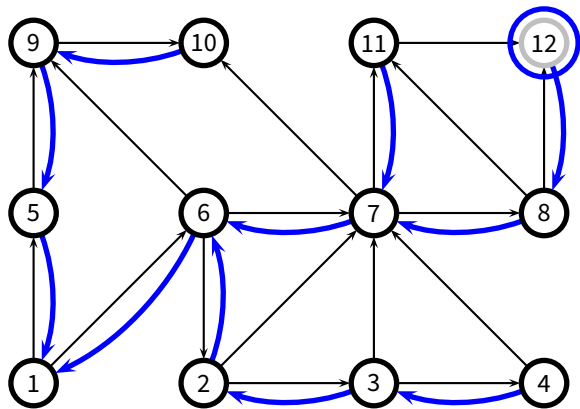

$u = 12$

$Q = \emptyset$

# BFS Algorithm

**BFS**( $G, s$ )

```
1  for each vertex  $u \in V(G) \setminus \{s\}$ 
2       $color[u] = \text{WHITE}$ 
3       $d[u] = \infty$ 
4       $\pi[u] = \text{NIL}$ 
5   $color[s] = \text{GRAY}$ 
6   $d[s] = 0$ 
7   $\pi[s] = \text{NIL}$ 
8   $Q = \emptyset$ 
9  ENQUEUE( $Q, s$ )
10 while  $Q \neq \emptyset$ 
11      $u = \text{DEQUEUE}(Q)$ 
12     for each  $v \in \text{Adj}[u]$ 
13         if  $color[v] == \text{WHITE}$ 
14              $color[v] = \text{GRAY}$ 
15              $d[v] = d[u] + 1$ 
16              $\pi[v] = u$ 
17             ENQUEUE( $Q, v$ )
18      $color[u] = \text{BLACK}$ 
```

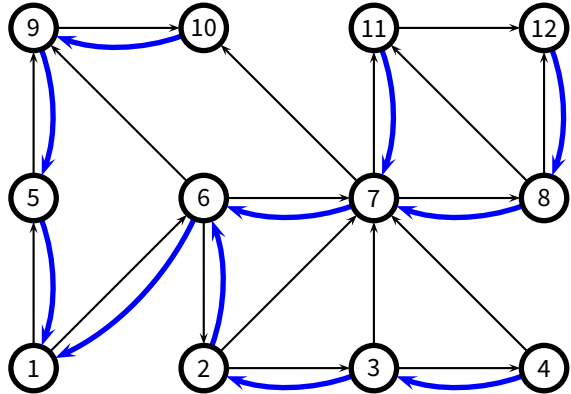

**BFS**( $G, s$ )

```
1  for each vertex  $u \in V(G) \setminus \{s\}$ 
2       $color[u] = \text{WHITE}$ 
3       $d[u] = \infty$ 
4       $\pi[u] = \text{NIL}$ 
5   $color[s] = \text{GRAY}$ 
6   $d[s] = 0$ 
7   $\pi[s] = \text{NIL}$ 
8   $Q = \emptyset$ 
9  ENQUEUE( $Q, s$ )
10 while  $Q \neq \emptyset$ 
11      $u = \text{DEQUEUE}(Q)$ 
12     for each  $v \in \text{Adj}[u]$ 
13         if  $color[v] == \text{WHITE}$ 
14              $color[v] = \text{GRAY}$ 
15              $d[v] = d[u] + 1$ 
16              $\pi[v] = u$ 
17             ENQUEUE( $Q, v$ )
18      $color[u] = \text{BLACK}$ 
```

**BFS**( $G, s$ )

```
1  for each vertex  $u \in V(G) \setminus \{s\}$ 
2       $color[u] = \text{WHITE}$ 
3       $d[u] = \infty$ 
4       $\pi[u] = \text{NIL}$ 
5   $color[s] = \text{GRAY}$ 
6   $d[s] = 0$ 
7   $\pi[s] = \text{NIL}$ 
8   $Q = \emptyset$ 
9  ENQUEUE( $Q, s$ )
10 while  $Q \neq \emptyset$ 
11      $u = \text{DEQUEUE}(Q)$ 
12     for each  $v \in \text{Adj}[u]$ 
13         if  $color[v] == \text{WHITE}$ 
14              $color[v] = \text{GRAY}$ 
15              $d[v] = d[u] + 1$ 
16              $\pi[v] = u$ 
17             ENQUEUE( $Q, v$ )
18      $color[u] = \text{BLACK}$ 
```

- We enqueue a vertex only if it is white, and we immediately color it gray; thus, we enqueue every vertex *at most once*

**BFS**( $G, s$ )

```
1  for each vertex  $u \in V(G) \setminus \{s\}$ 
2       $color[u] = \text{WHITE}$ 
3       $d[u] = \infty$ 
4       $\pi[u] = \text{NIL}$ 
5   $color[s] = \text{GRAY}$ 
6   $d[s] = 0$ 
7   $\pi[s] = \text{NIL}$ 
8   $Q = \emptyset$ 
9  ENQUEUE( $Q, s$ )
10 while  $Q \neq \emptyset$ 
11      $u = \text{DEQUEUE}(Q)$ 
12     for each  $v \in \text{Adj}[u]$ 
13         if  $color[v] == \text{WHITE}$ 
14              $color[v] = \text{GRAY}$ 
15              $d[v] = d[u] + 1$ 
16              $\pi[v] = u$ 
17             ENQUEUE( $Q, v$ )
18      $color[u] = \text{BLACK}$ 
```

- We enqueue a vertex only if it is white, and we immediately color it gray; thus, we enqueue every vertex *at most once*
- So, the (dequeue) while loop executes  $O(|V|)$  times

**BFS**( $G, s$ )

```
1  for each vertex  $u \in V(G) \setminus \{s\}$ 
2       $color[u] = \text{WHITE}$ 
3       $d[u] = \infty$ 
4       $\pi[u] = \text{NIL}$ 
5   $color[s] = \text{GRAY}$ 
6   $d[s] = 0$ 
7   $\pi[s] = \text{NIL}$ 
8   $Q = \emptyset$ 
9  ENQUEUE( $Q, s$ )
10 while  $Q \neq \emptyset$ 
11      $u = \text{DEQUEUE}(Q)$ 
12     for each  $v \in \text{Adj}[u]$ 
13         if  $color[v] == \text{WHITE}$ 
14              $color[v] = \text{GRAY}$ 
15              $d[v] = d[u] + 1$ 
16              $\pi[v] = u$ 
17             ENQUEUE( $Q, v$ )
18      $color[u] = \text{BLACK}$ 
```

- We enqueue a vertex only if it is white, and we immediately color it gray; thus, we enqueue every vertex *at most once*
- So, the (dequeue) while loop executes  $O(|V|)$  times
- For each vertex  $u$ , the inner loop executes  $\Theta(|E_u|)$ , for a total of  $O(|E|)$  steps

**BFS**( $G, s$ )

```
1  for each vertex  $u \in V(G) \setminus \{s\}$ 
2       $color[u] = \text{WHITE}$ 
3       $d[u] = \infty$ 
4       $\pi[u] = \text{NIL}$ 
5   $color[s] = \text{GRAY}$ 
6   $d[s] = 0$ 
7   $\pi[s] = \text{NIL}$ 
8   $Q = \emptyset$ 
9  ENQUEUE( $Q, s$ )
10 while  $Q \neq \emptyset$ 
11      $u = \text{DEQUEUE}(Q)$ 
12     for each  $v \in \text{Adj}[u]$ 
13         if  $color[v] == \text{WHITE}$ 
14              $color[v] = \text{GRAY}$ 
15              $d[v] = d[u] + 1$ 
16              $\pi[v] = u$ 
17             ENQUEUE( $Q, v$ )
18      $color[u] = \text{BLACK}$ 
```

- We enqueue a vertex only if it is white, and we immediately color it gray; thus, we enqueue every vertex *at most once*
- So, the (dequeue) while loop executes  $O(|V|)$  times
- For each vertex  $u$ , the inner loop executes  $\Theta(|E_u|)$ , for a total of  $O(|E|)$  steps
- So,  $O(|V| + |E|)$

# Depth-First Search

- Immediately follow the links of the most recently-visited vertex, then backtrack when you reach a dead-end
  - ▶ i.e., backtrack when the current vertex has no more adjacent vertices that have not yet been visited

- Immediately follow the links of the most recently-visited vertex, then backtrack when you reach a dead-end
  - ▶ i.e., backtrack when the current vertex has no more adjacent vertices that have not yet been visited
- *Input:  $G = (V, E)$* 
  - ▶ explores the graph, touching *all vertices*

- Immediately follow the links of the most recently-visited vertex, then backtrack when you reach a dead-end
  - ▶ i.e., backtrack when the current vertex has no more adjacent vertices that have not yet been visited
- *Input:  $G = (V, E)$* 
  - ▶ explores the graph, touching *all vertices*
  - ▶ produces a ***depth-first forest***, consisting of all the ***depth-first trees*** defined by the DFS exploration

- Immediately follow the links of the most recently-visited vertex, then backtrack when you reach a dead-end
  - ▶ i.e., backtrack when the current vertex has no more adjacent vertices that have not yet been visited
- *Input:  $G = (V, E)$* 
  - ▶ explores the graph, touching *all vertices*
  - ▶ produces a **depth-first forest**, consisting of all the **depth-first trees** defined by the DFS exploration
  - ▶ associates **two time-stamps** to each vertex
    - ▶  $d[u]$  records when  $u$  is first discovered
    - ▶  $f[u]$  records when DFS finishes examining  $u$ 's edges, and therefore backtracks from  $u$

## DFS( $G$ )

```
1 for each vertex  $u \in V(G)$ 
2    $color[u] = WHITE$ 
3    $\pi[u] = NIL$ 
4  $time = 0$  // “global” variable
5 for each vertex  $u \in V(G)$ 
6   if  $color[u] == WHITE$ 
7     DFS-VISIT( $u$ )
```

## DFS-VISIT( $u$ )

```
1  $color[u] = GREY$ 
2  $time = time + 1$ 
3  $d[u] = time$ 
4 for each  $v \in Adj[u]$ 
5   if  $color[v] == WHITE$ 
6      $\pi[v] = u$ 
7     DFS-VISIT( $v$ )
8  $color[u] = BLACK$ 
9  $time = time + 1$ 
10  $f[u] = time$ 
```



- The loop in **DFS-VISIT**( $u$ ) (lines 4–7) accounts for  $\Theta(|E_u|)$

- The loop in **DFS-VISIT**( $u$ ) (lines 4–7) accounts for  $\Theta(|E_u|)$
- We call **DFS-VISIT**( $u$ ) *once* for each vertex  $u$ 
  - ▶ either in **DFS**, or recursively in **DFS-VISIT**
  - ▶ because we call it only if  $color[u] = \text{WHITE}$ , but then we immediately set  $color[u] = \text{GREY}$

- The loop in **DFS-VISIT**( $u$ ) (lines 4–7) accounts for  $\Theta(|E_u|)$
- We call **DFS-VISIT**( $u$ ) *once* for each vertex  $u$ 
  - ▶ either in **DFS**, or recursively in **DFS-VISIT**
  - ▶ because we call it only if  $color[u] = \text{WHITE}$ , but then we immediately set  $color[u] = \text{GREY}$
- So, the overall complexity is  $\Theta(|V| + |E|)$

# Applications of DFS: Topological Sort

# Applications of DFS: Topological Sort

- **Problem:** (topological sort)

Given a *directed acyclic graph* (DAG)

- ▶ find an ordering of vertices such that you only end up with *forward links*

# Applications of DFS: Topological Sort

## ■ **Problem:** (topological sort)

Given a *directed acyclic graph* (DAG)

- ▶ find an ordering of vertices such that you only end up with *forward links*

## ■ **Example:** dependencies in software packages

- ▶ find an installation order for a set of software packages
- ▶ such that every package is installed only after all the packages it depends on

# Topological Sort Algorithm

# Topological Sort Algorithm

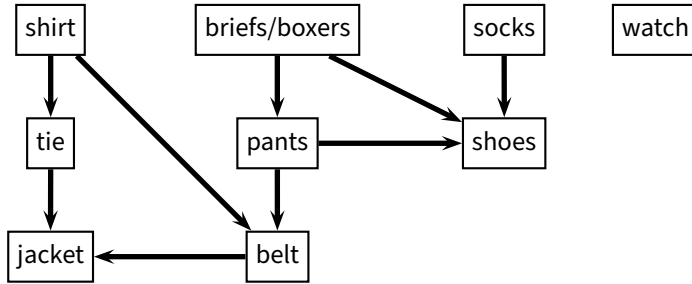

# Topological Sort Algorithm

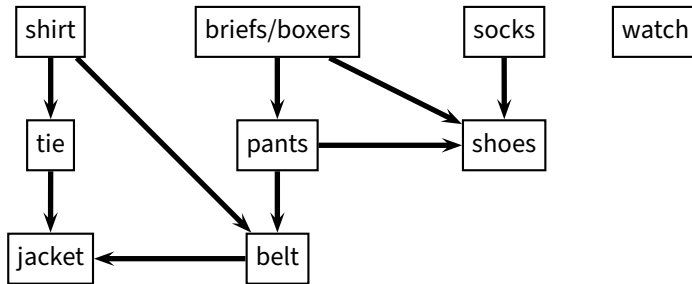

## TOPOLOGICAL-SORT ( $G$ )

- 1 **DFS**( $G$ )
- 2 output  $V$  sorted in reverse order of  $f[\cdot]$